

Start Writing

CAPITAL & small

Letters

Compiled by:
Anchal Gupta



Name :

Class : Sec : Roll. No. :

School :



ADISRI PUBLICATIONS™

Standing, Sleeping & Slanting Lines

Join the dots to make Standing Lines.



Join the dots to make Sleeping Lines.







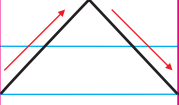
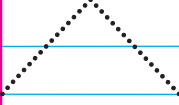
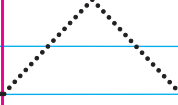
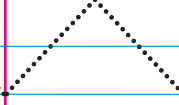
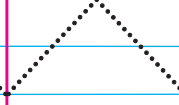
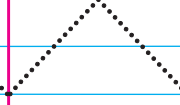
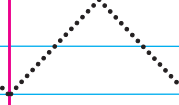
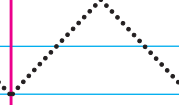
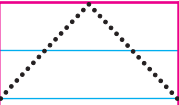
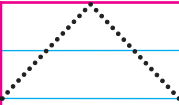
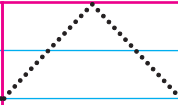
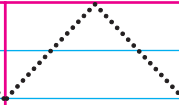
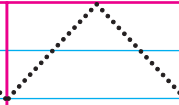
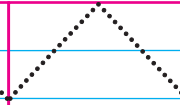

Join the dots to make Slanting Lines.

Date

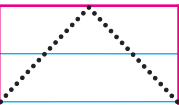
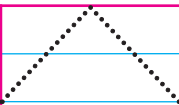
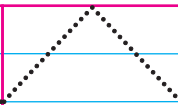
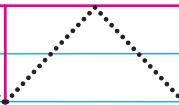
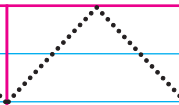
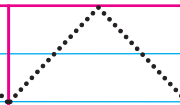









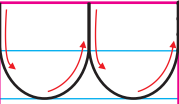
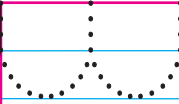

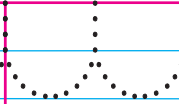

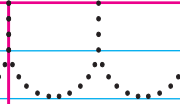
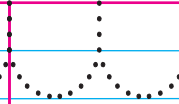

Zig Zag, Up Curve & Down Curve Lines

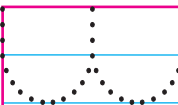
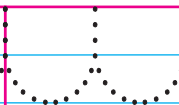
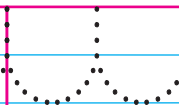
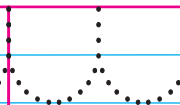
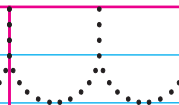
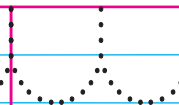
Join the dots to make Zig Zag Lines.









Join the dots to make Up Curve Lines.

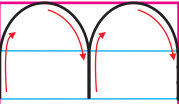
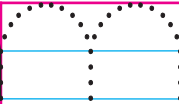
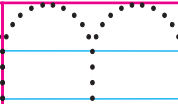
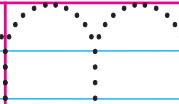
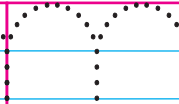
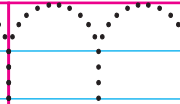
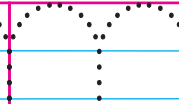
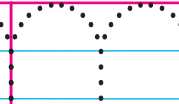
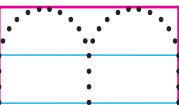
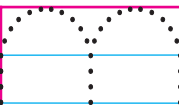
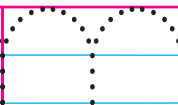
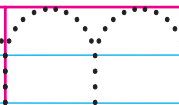
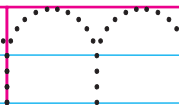
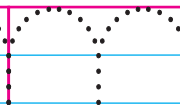
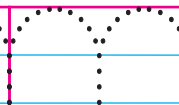
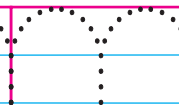
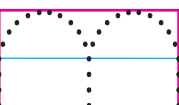



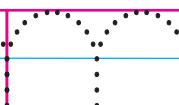
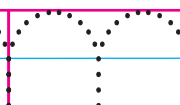





















Join the dots to make Down Curve Lines.

							
							
							

😊 Good ☆ Best ☆ Excellent























Standing & Curve Lines

Join the dots to make Standing Lines.



























Join the dots to make Curves Lines.





Join the dots to make Curves Lines.

Date



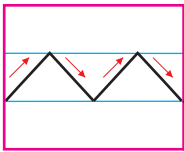
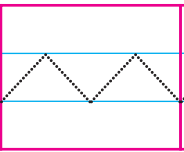
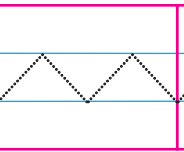
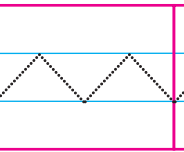
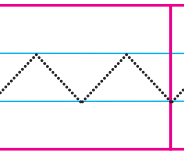
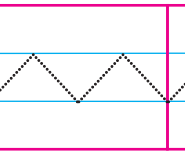
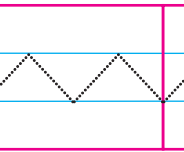
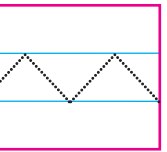
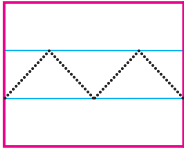
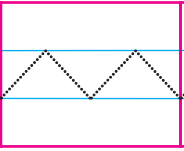
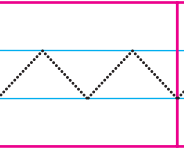
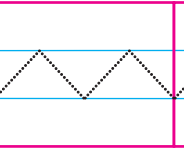
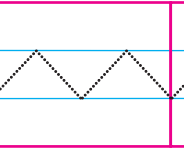
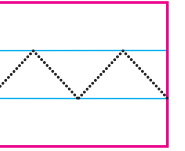

Zig Zag, Up Curve & Down Curve Lines

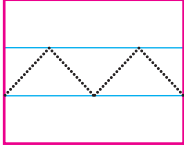
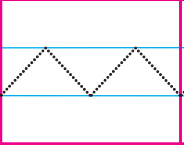
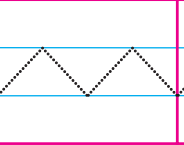
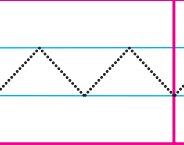
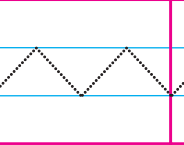
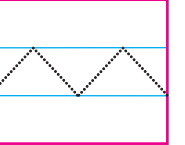
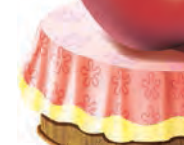
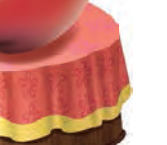
Join the dots to make Zig Zag Lines.

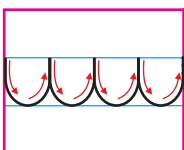
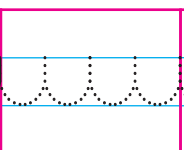
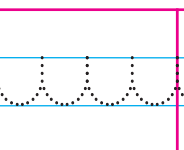
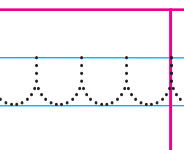
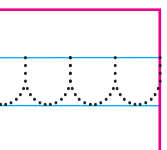

Join the dots to make Up Curve Lines.

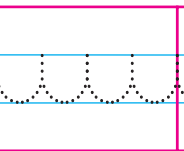
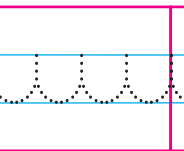
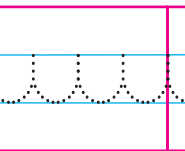
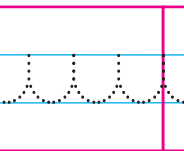

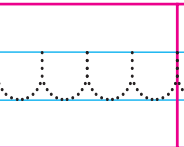
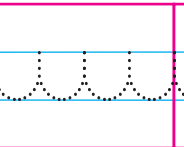
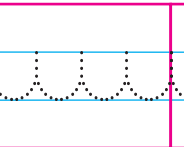
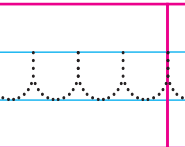
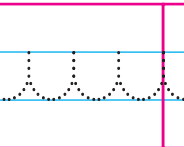

Join the dots to make Down Curve Lines.

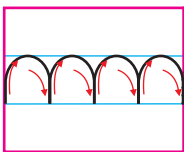
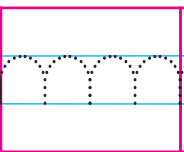
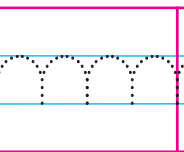
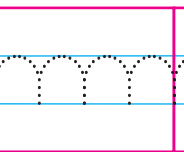
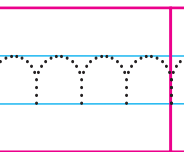
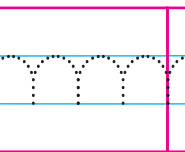
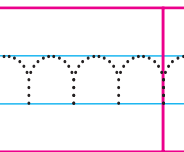
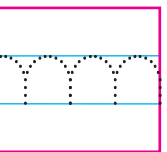
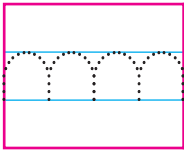
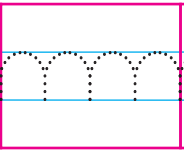
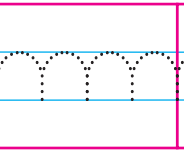
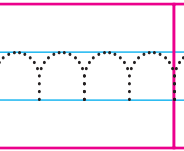
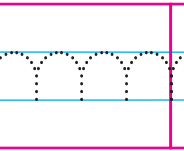
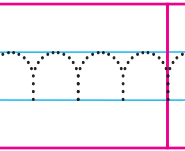
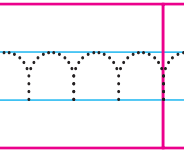
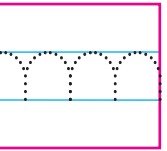
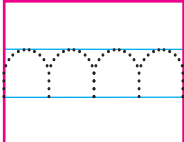
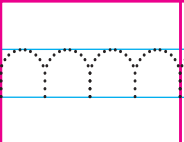
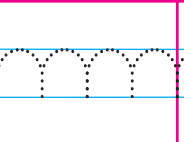
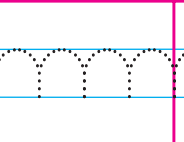
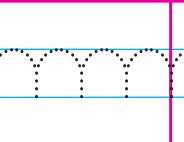
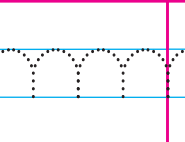
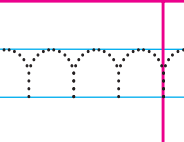
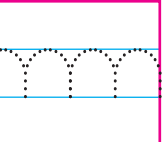
😊 Good ☆ Best ☆ Excellent

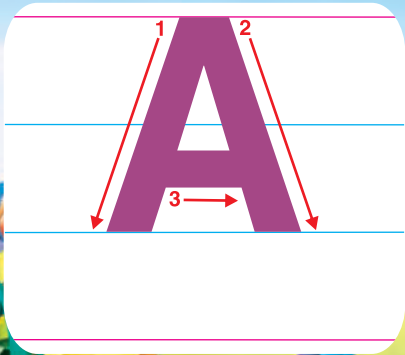

APPLE



TRACE & WRITE

Date



a

ant

TRACE & WRITE



a	a	a	a	a	a	a
a	a	a	a	a	a	a
a	a	a	a	a	a	a
a	a	a	a	a	a	a

😊 Good ☆ Best ☆ Excellent

Date

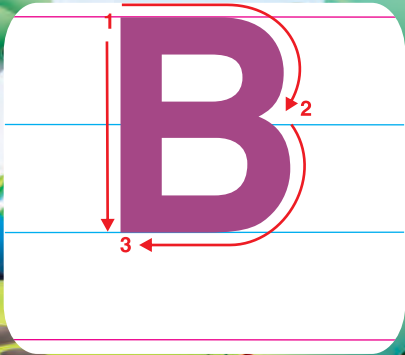

BALL



TRACE & WRITE

B	B	B	B	B	B	B
B	B	B	B	B	B	B
B	B	B	B	B	B	B
B	B	B	B	B	B	B

Date

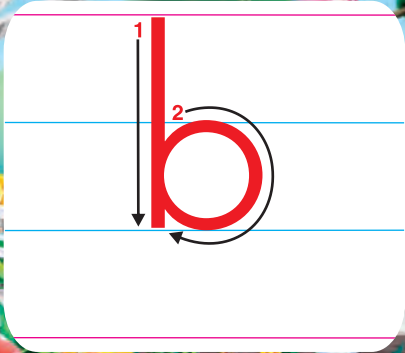

balloon

TRACE & WRITE



b	b	b	b	b	b	b
b	b	b	b	b	b	b
b	b	b	b	b	b	b
b	b	b	b	b	b	b

😊 Good ☆ Best 😊 Excellent

Date

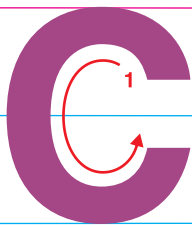

CAT



TRACE & WRITE

C	C	C	C	C	C	C
C	C	C	C	C	C	C
C	C	C	C	C	C	C
C	C	C	C	C	C	C

Date



TRACE & WRITE



C	○	○	○	○	○	○
○	○	○	○	○	○	○
○	○	○	○	○	○	○
○	○	○	○	○	○	○

😊 Good ☆ Best ☆ Excellent

Date

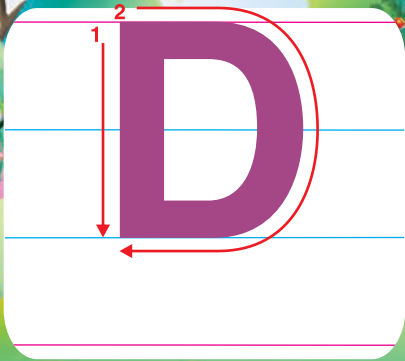

DOG

TRACE & WRITE



D	D	D	D	D	D	D
D	D	D	D	D	D	D
D	D	D	D	D	D	D
D	D	D	D	D	D	D

Date

doll



TRACE & WRITE



d	d	d	d	d	d	d
d	d	d	d	d	d	d
d	d	d	d	d	d	d
d	d	d	d	d	d	d

Good
 Best
 Excellent

Date

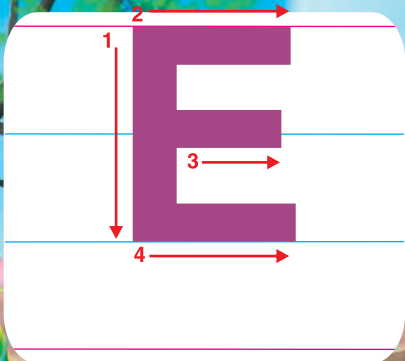

ELEPHANT

TRACE & WRITE



E						

Date



eagle

TRACE & WRITE



e	e	e	e	e	e	e
e	e	e	e	e	e	e
e	e	e	e	e	e	e
e	e	e	e	e	e	e

😊 Good ☆ Best ☆ Excellent

Date

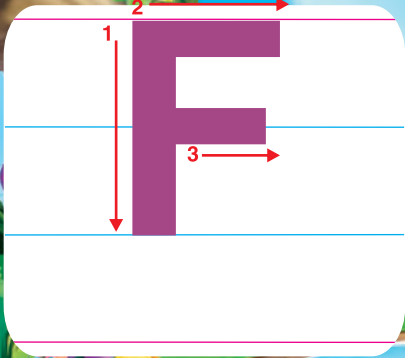

FISH

TRACE & WRITE



F						

Date

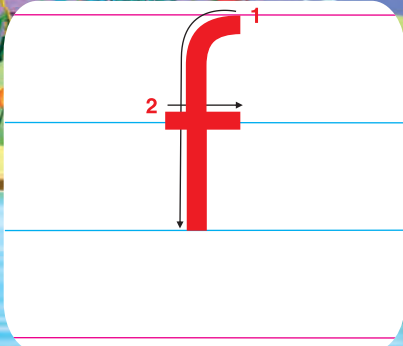

frog

TRACE & WRITE 

f	f	f	f	f	f	f
f	f	f	f	f	f	f
f	f	f	f	f	f	f
f	f	f	f	f	f	f

😊 Good ☆ Best 😊 Excellent

Date

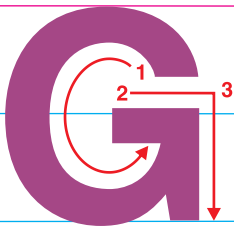

GOAT



TRACE & WRITE



Date

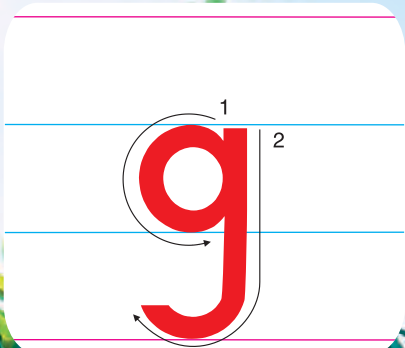

giraffe



TRACE & WRITE



g	g	g	g	g	g	g
g	g	g	g	g	g	g
g	g	g	g	g	g	g
g	g	g	g	g	g	g

😊 Good ☆ Best 😊 Excellent

Date

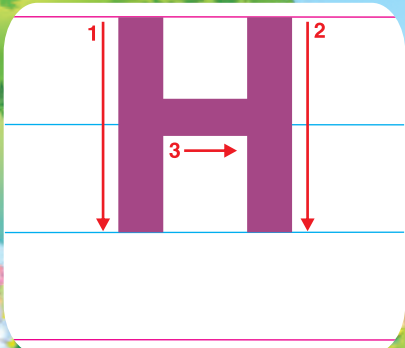

HEN



TRACE & WRITE

Date

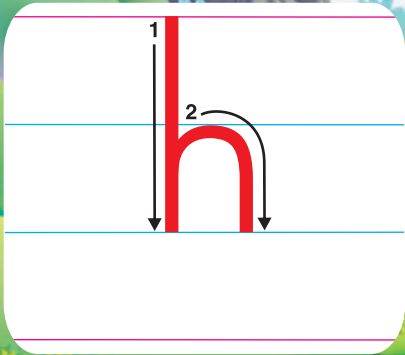

horse

TRACE & WRITE



h	h	h	h	h	h	h
h	h	h	h	h	h	h
h	h	h	h	h	h	h
h	h	h	h	h	h	h

☺ Good ☆ Best ☺☺☺ Excellent

Date



Write the first letter of the following pictures.



P P L E



O R S E



A R



O A T



L E P H A N T



O G



I S H

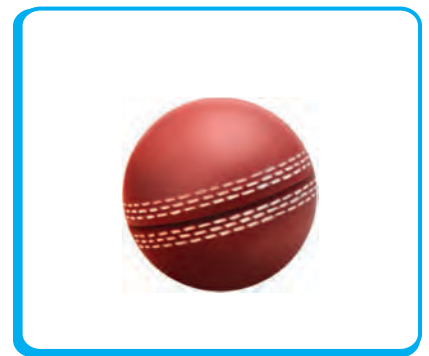

A L L

Date



Write the first letter of the following in small letter :



e n



a t



a g l e



a l l o o n



i r a f f e



r o g



o l l



n t

😊 Good ☆ Best ☆ Excellent

Date

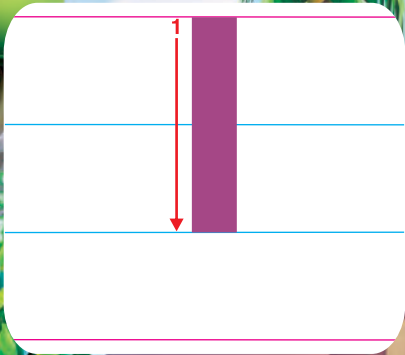

ICE-CREAM

TRACE & WRITE





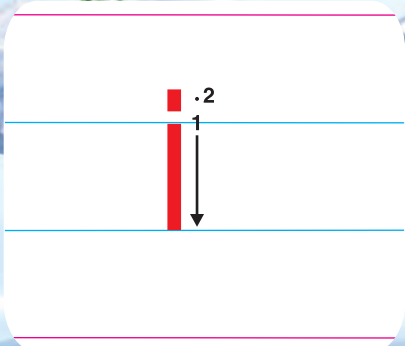

Date

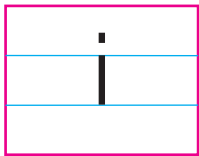
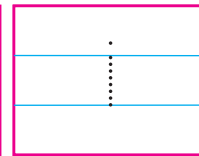
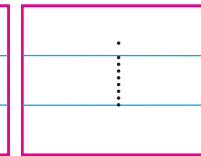
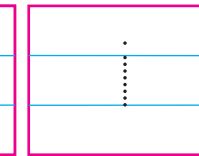
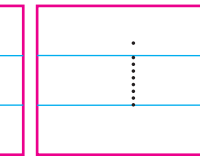
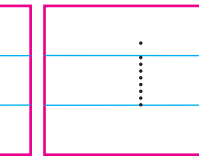
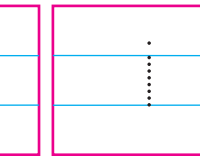
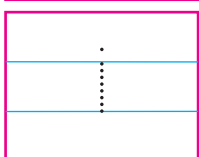
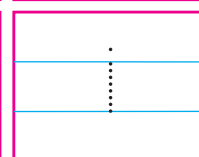
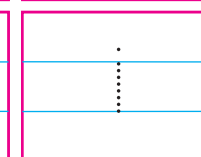
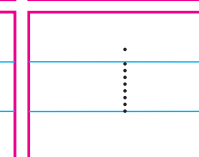
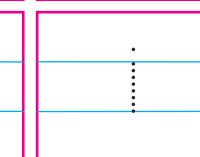
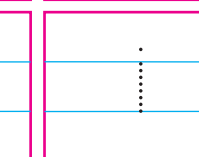
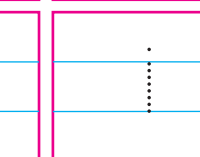
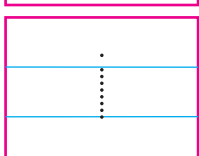
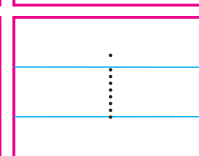
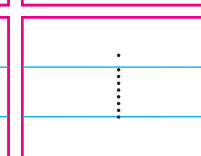
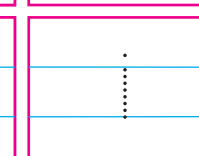
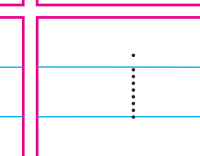
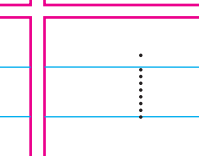
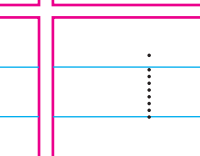
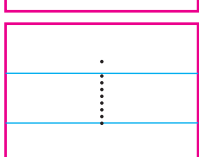
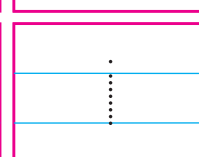
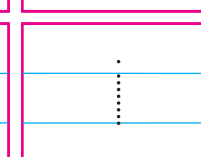
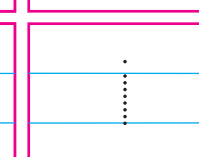
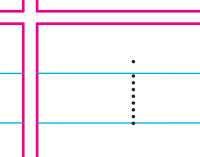
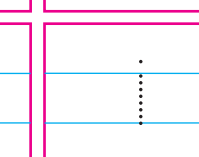
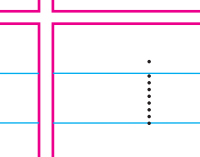
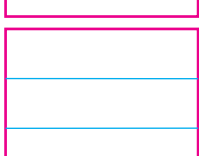

igloo

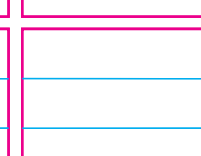
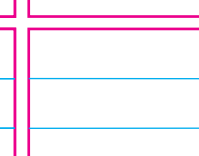
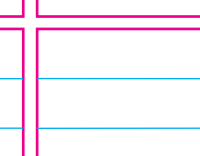
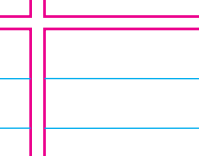
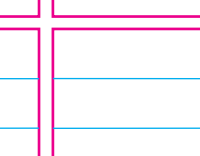
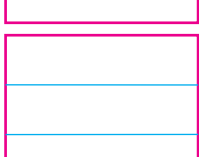
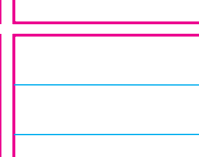
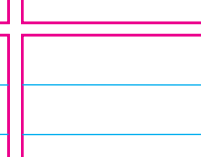
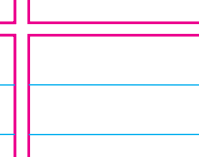
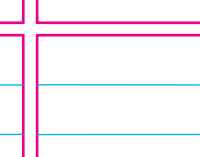
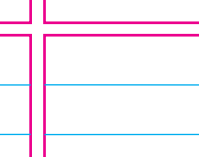
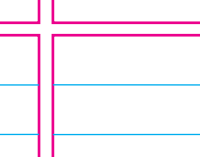
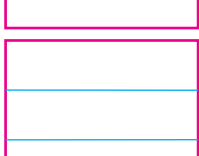
TRACE & WRITE 

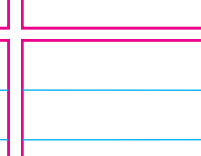
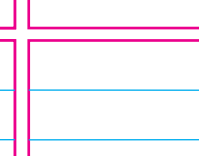
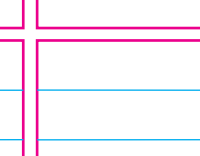
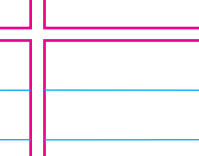
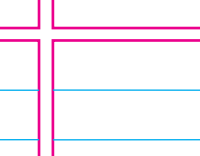
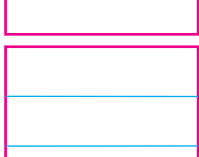
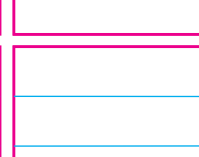
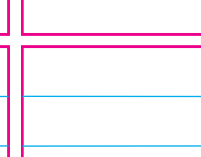
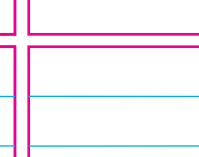
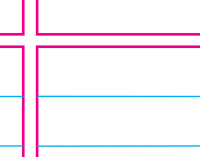
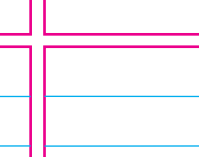
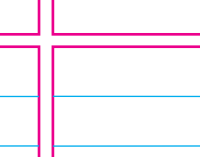
 Good  Best  Excellent

Date



TRACE & WRITE

J	J	J	J	J	J	J
J	J	J	J	J	J	J
J	J	J	J	J	J	J
J	J	J	J	J	J	J

Date

• 2

1

jug



TRACE & WRITE



j	J	J	J	J	J	J
J	J	J	J	J	J	J
J	J	J	J	J	J	J
J	J	J	J	J	J	J

Good
 Best
 Excellent

Date

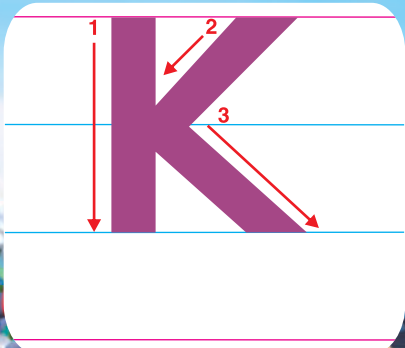

KITE



TRACE & WRITE

K	K	K	K	K	K	K
K	K	K	K	K	K	K
K	K	K	K	K	K	K
K	K	K	K	K	K	K

Date

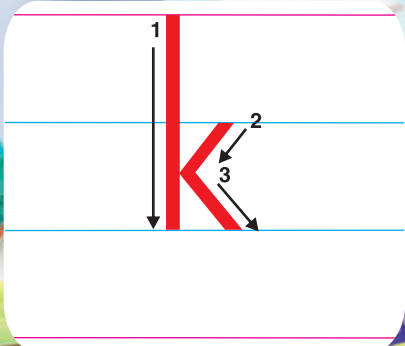

kangaroo



TRACE & WRITE



k	k	k	k	k	k	k
k	k	k	k	k	k	k
k	k	k	k	k	k	k
k	k	k	k	k	k	k

😊 Good ☆ Best ☆ Excellent

Date



TRACE & WRITE



Date

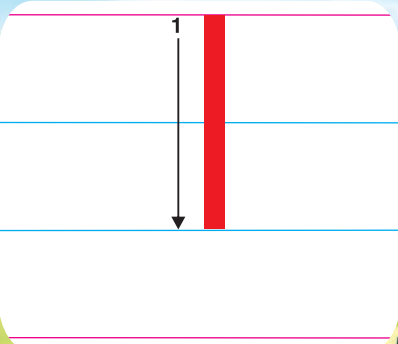

lotus

TRACE & WRITE



😊 Good ☆ Best ☆ Excellent

Date

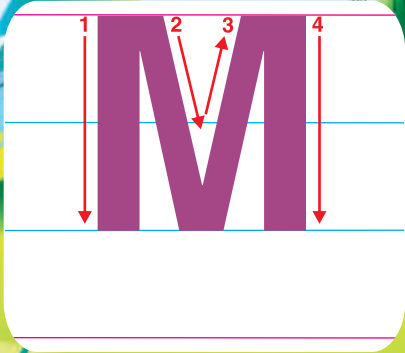

MONKEY



TRACE & WRITE

M	M	M	M	M	M	M
M	M	M	M	M	M	M
M	M	M	M	M	M	M
M	M	M	M	M	M	M

Date

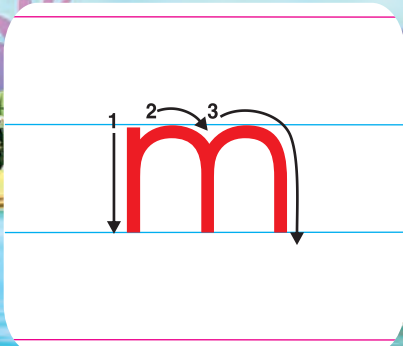

mango

TRACE & WRITE 

m	m	m	m	m	m	m
m	m	m	m	m	m	m
m	m	m	m	m	m	m
m	m	m	m	m	m	m

 Good  Best  Excellent

Date

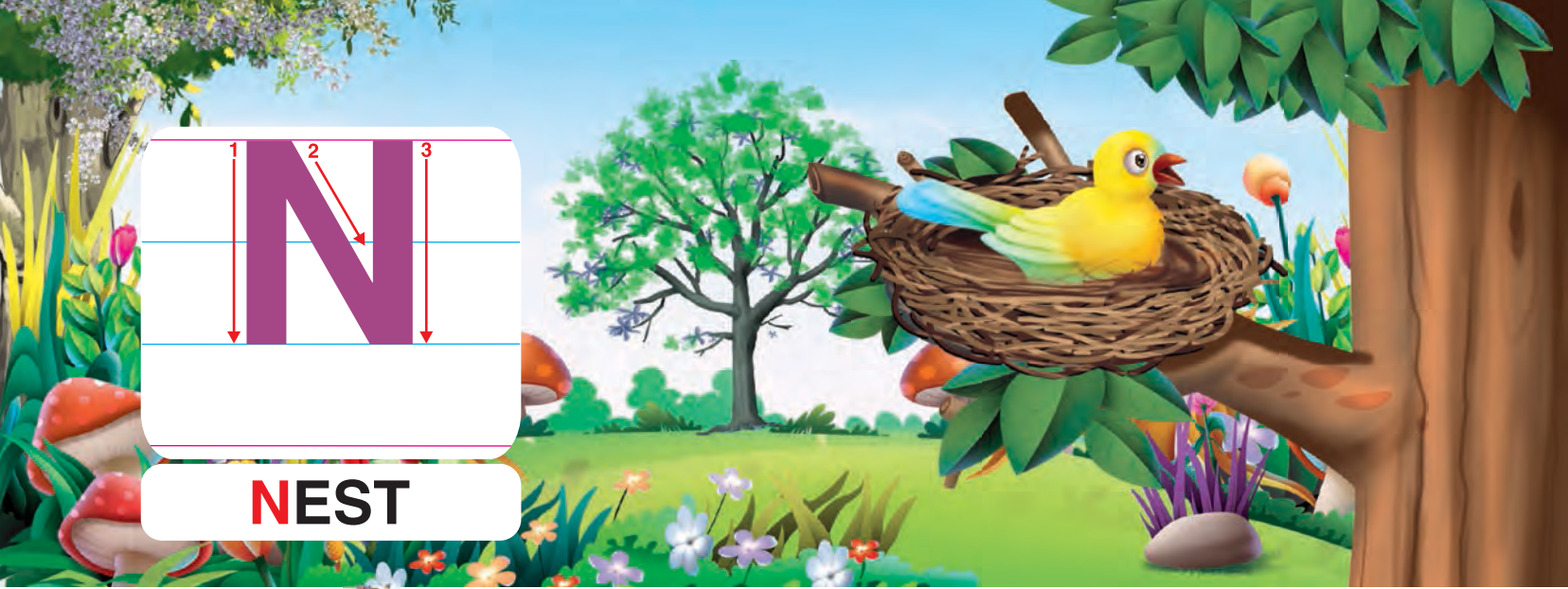

TRACE & WRITE



N	N	N	N	N	N	N
N	N	N	N	N	N	N
N	N	N	N	N	N	N
N	N	N	N	N	N	N

Date

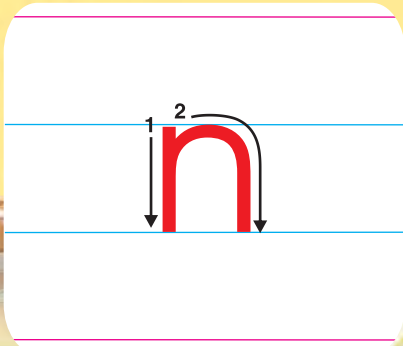

nurse



TRACE & WRITE



n	n	n	n	n	n	n
n	n	n	n	n	n	n
n	n	n	n	n	n	n
n	n	n	n	n	n	n

😊 Good ☆ Best ☆ Excellent

Date

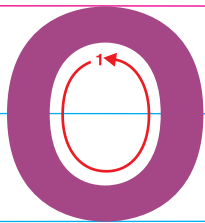

OWL



TRACE & WRITE



Date

☆ Good ☆ Best ☆ Excellent

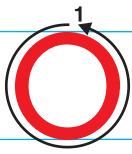

orange



TRACE & WRITE



O	○	○	○	○	○	○
○	○	○	○	○	○	○
○	○	○	○	○	○	○
○	○	○	○	○	○	○

😊 Good ☆ Best ☆ Excellent

Date



TRACE & WRITE



P	P	P	P	P	P	P
P	P	P	P	P	P	P
P	P	P	P	P	P	P
P	P	P	P	P	P	P

Date

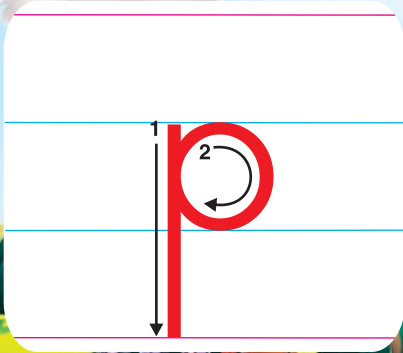

peacock

TRACE & WRITE



p	p	p	p	p	p	p
p	p	p	p	p	p	p
p	p	p	p	p	p	p
p	p	p	p	p	p	p

😊 Good ☆ Best ☆ Excellent

Date



Match the pictures with the given letters.



Q



R



I



N



M



L



K



Date



Identify and circle the first letter for each picture:



G H I



T L S



F H G



H I J

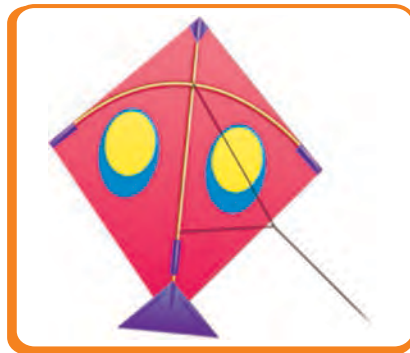

I T K



E N S



W O L



O C P



N G M



QUEEN

TRACE & WRITE

Q	Q	Q	Q	Q	Q	Q
Q	Q	Q	Q	Q	Q	Q
Q	Q	Q	Q	Q	Q	Q
Q	Q	Q	Q	Q	Q	Q

Date

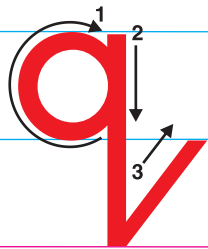

queue



TRACE & WRITE



q	q	q	q	q	q	q
q	q	q	q	q	q	q
q	q	q	q	q	q	q
q	q	q	q	q	q	q

😊 Good ☆ Best ☆ Excellent

Date

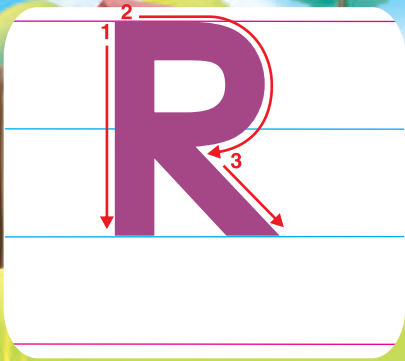

RAT

TRACE & WRITE



R	R	R	R	R	R	R
R	R	R	R	R	R	R
R	R	R	R	R	R	R
R	R	R	R	R	R	R

Date

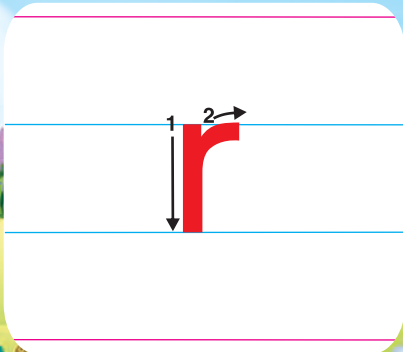

rabbit

TRACE & WRITE



r	r	r	r	r	r	r
r	r	r	r	r	r	r
r	r	r	r	r	r	r
r	r	r	r	r	r	r

😊 Good ☆ Best 😊 Excellent

Date

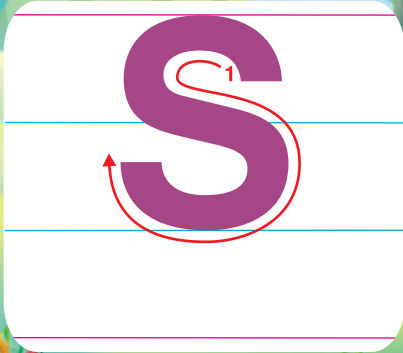

SHIP

TRACE & WRITE



S	S	S	S	S	S	S
S	S	S	S	S	S	S
S	S	S	S	S	S	S
S	S	S	S	S	S	S

Date



S

swan

TRACE & WRITE



S	S	S	S	S	S	S
S	S	S	S	S	S	S
S	S	S	S	S	S	S
S	S	S	S	S	S	S

😊 Good ☆ Best 😊 Excellent

Date

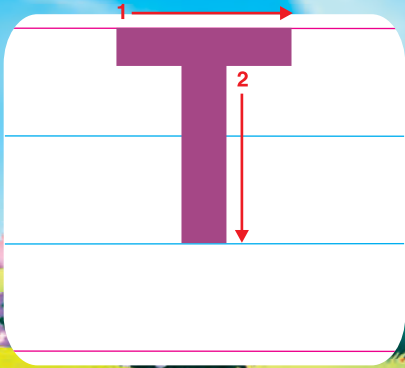

TIGER



TRACE & WRITE



Date



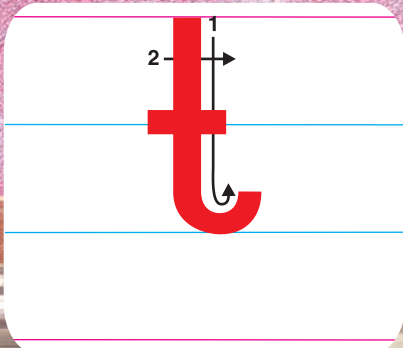

























Good Best Excellent



telephone



TRACE & WRITE 

😊 Good ☆ Best ☆ Excellent

Date

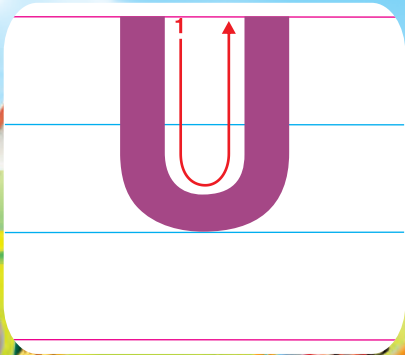

UMBRELLA

TRACE & WRITE



U	U	U	U	U	U	U
U	U	U	U	U	U	U
U	U	U	U	U	U	U
U	U	U	U	U	U	U

Date

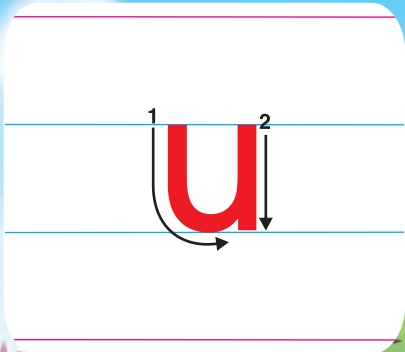

uniform



TRACE & WRITE



u	u	u	u	u	u	u
u	u	u	u	u	u	u
u	u	u	u	u	u	u
u	u	u	u	u	u	u

😊 Good ☆ Best ☆ Excellent

Date

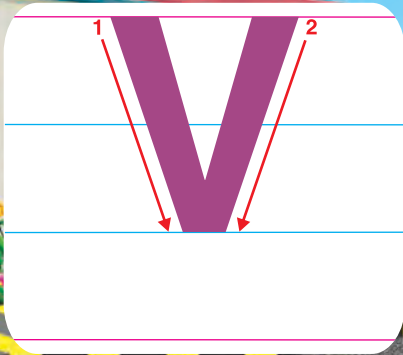

VAN

TRACE & WRITE



Date

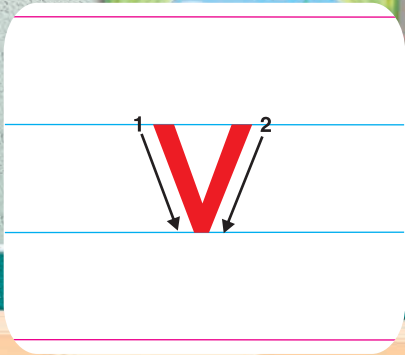
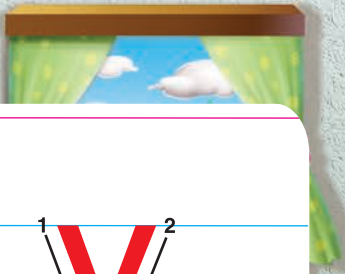

violin



TRACE & WRITE



😊 Good ☆ Best ☆ Excellent

Date

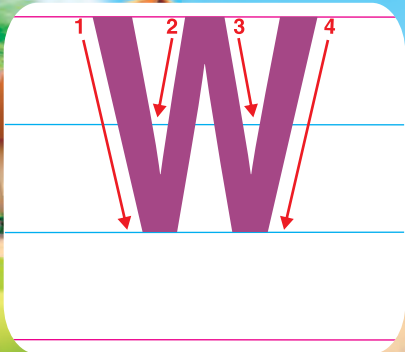

WATCH



TRACE & WRITE

Date

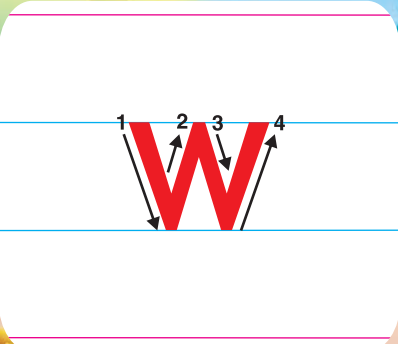

well

TRACE & WRITE



W	W	W	W	W	W	W
W	W	W	W	W	W	W
W	W	W	W	W	W	W
W	W	W	W	W	W	W

😊 Good ☆ Best ☆ Excellent

Date

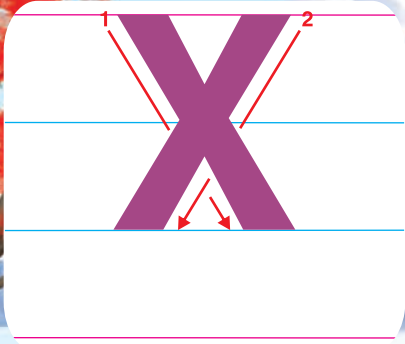

X-MAS TREE



TRACE & WRITE



Date

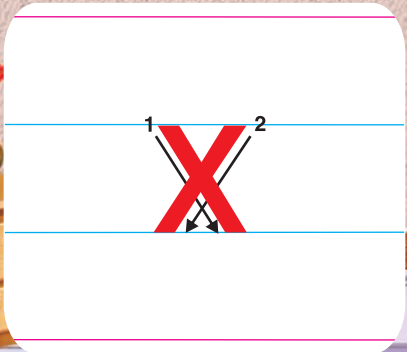

xylophone

TRACE & WRITE



X	X	X	X	X	X	X
X	X	X	X	X	X	X
X	X	X	X	X	X	X
X	X	X	X	X	X	X

😊 Good ☆ Best ☆ Excellent

Date

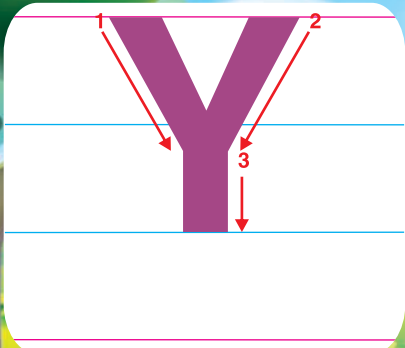

YACHT



TRACE & WRITE



Y	Y	Y	Y	Y	Y	Y
Y	Y	Y	Y	Y	Y	Y
Y	Y	Y	Y	Y	Y	Y
Y	Y	Y	Y	Y	Y	Y

Date



yo-yo



TRACE & WRITE



y	y	y	y	y	y	y
y	y	y	y	y	y	y
y	y	y	y	y	y	y
y	y	y	y	y	y	y

Good
 Best
 Excellent

Date

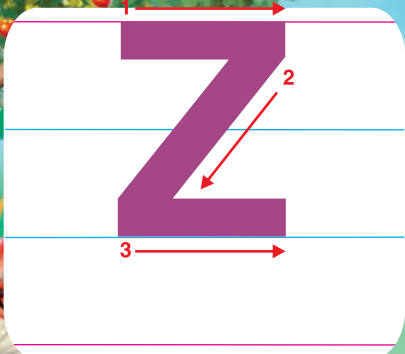

ZEBRA

TRACE & WRITE



Z						

Date



ZOO

TRACE & WRITE



Z	Z	Z	Z	Z	Z	Z
Z	Z	Z	Z	Z	Z	Z
Z	Z	Z	Z	Z	Z	Z
Z	Z	Z	Z	Z	Z	Z

😊 Good ☆ Best ☆ Excellent

Date



Write the first letter of the given pictures:



Blank writing lines for the Christmas tree.

Blank writing lines for the apple.

Blank writing lines for the kitten.

Blank writing lines for the tiger.



Blank writing lines for the telephone.

Blank writing lines for the dog.

Blank writing lines for the elephant.

Blank writing lines for the umbrella.



Blank writing lines for the zebra.

Blank writing lines for the rabbit.

Blank writing lines for the monkey.

Blank writing lines for the fish.

Date



Connect dots from A to Z & colour the picture.

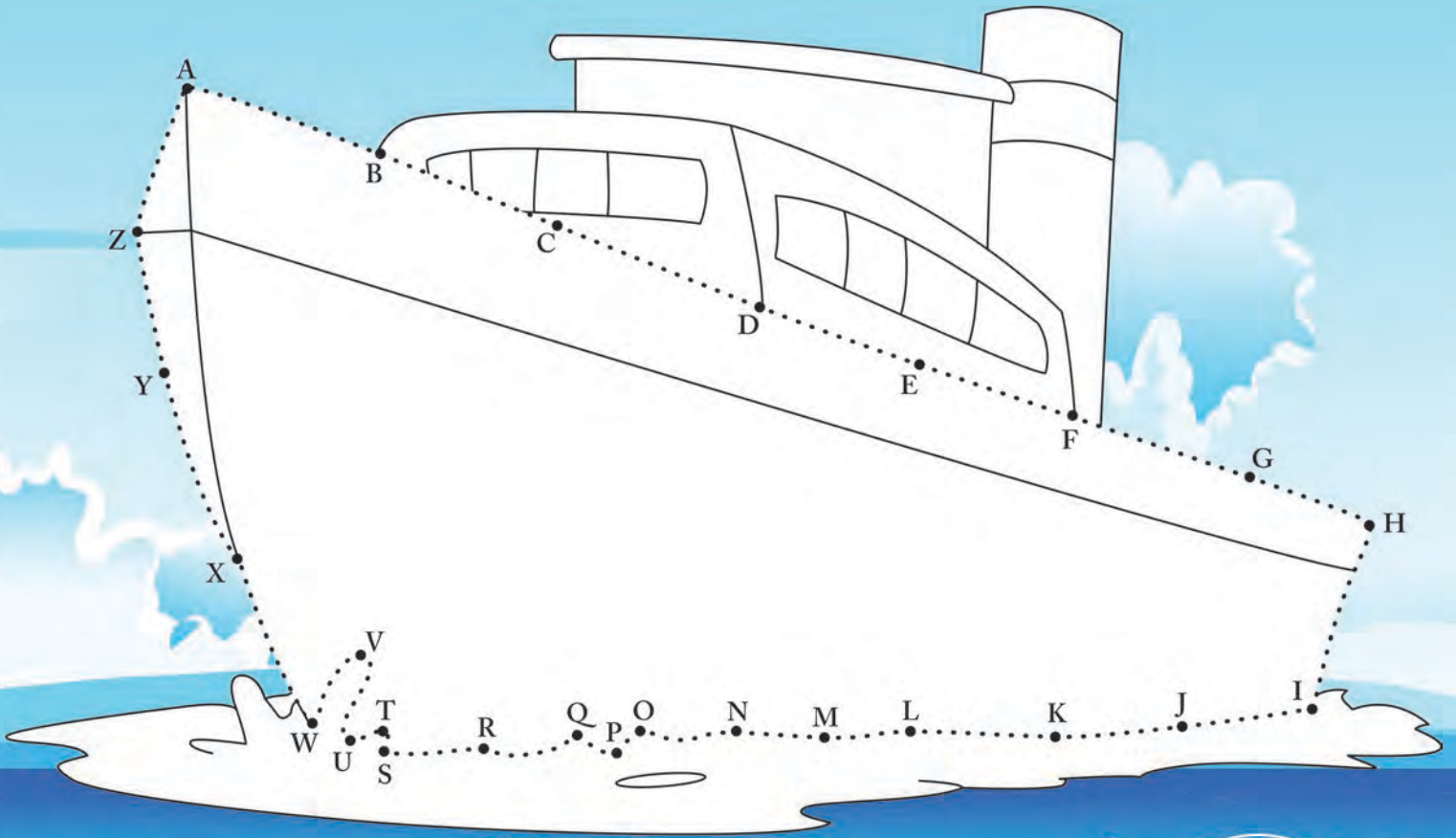

😊 Good ☆ Best ☆ Excellent

Date



LET'S TRACE CAPITAL LETTERS

A B C D E F G

H I J K L M N

O P Q R S T U

V W X Y Z



LET'S TRACE SMALL LETTERS

a b c d e f g

h i j k l m n

o p q r s t u

v w x y z

Date