

अक्षर



रचना



दिनांक



अनानास

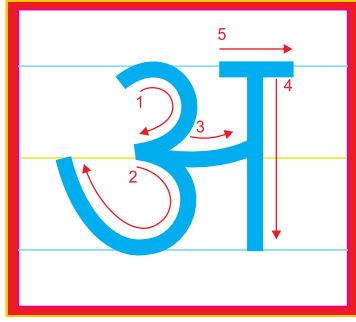

अनार

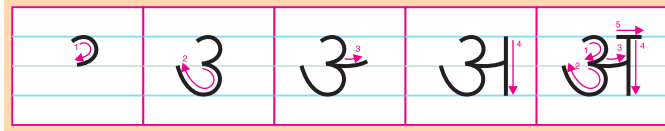

अभ्यास कीजिए-

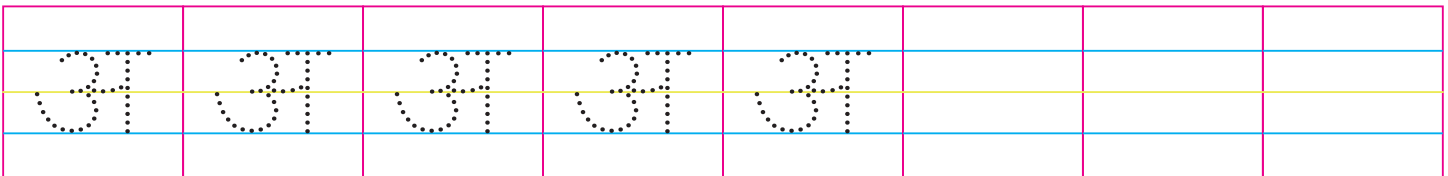
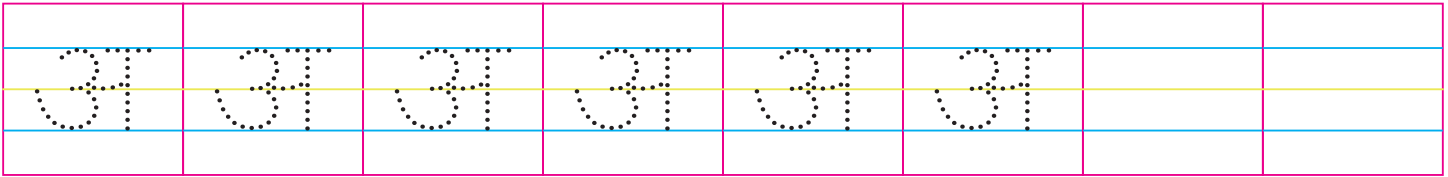
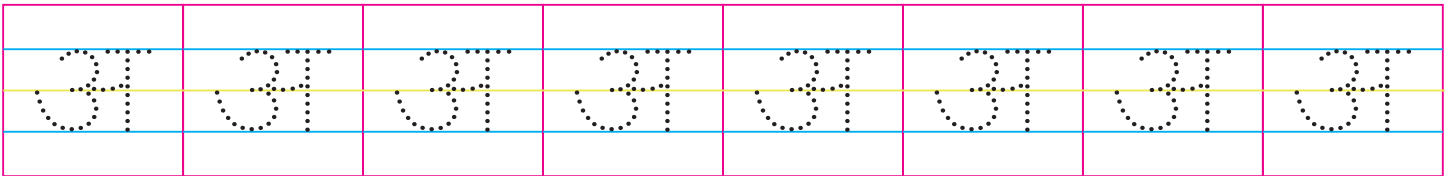

चित्र पहचानकर पहला अक्षर लिखिए व रंग भरिए-

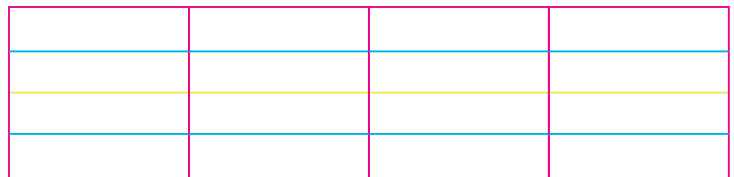
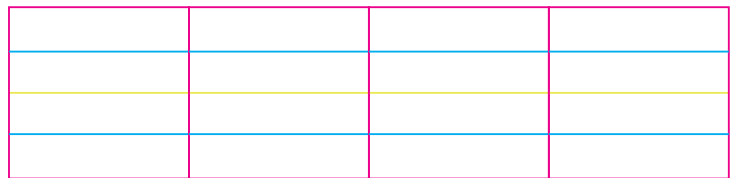
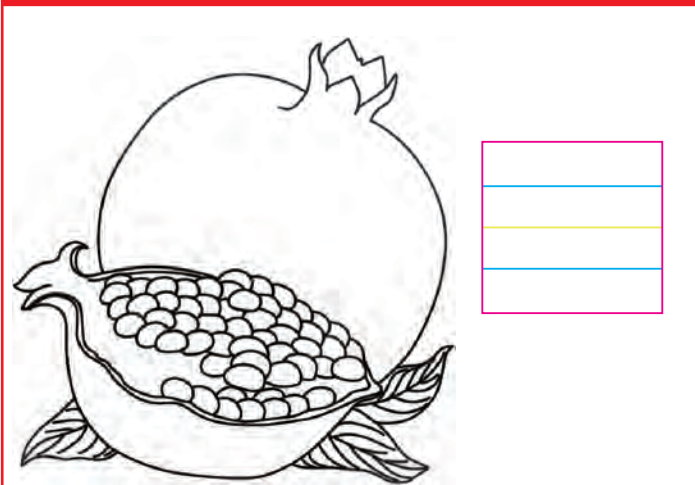

दिनांक:

हस्ताक्षर:

दिनांक



आलू

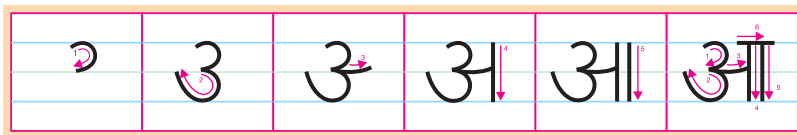
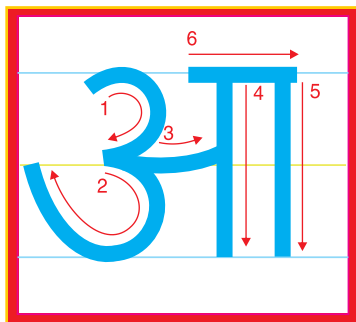

आम

अभ्यास कीजिए-

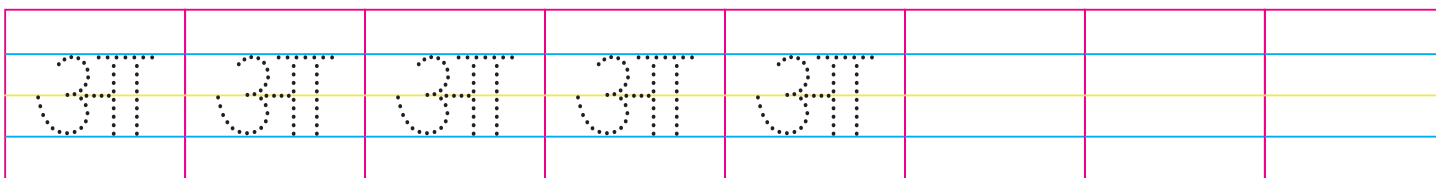
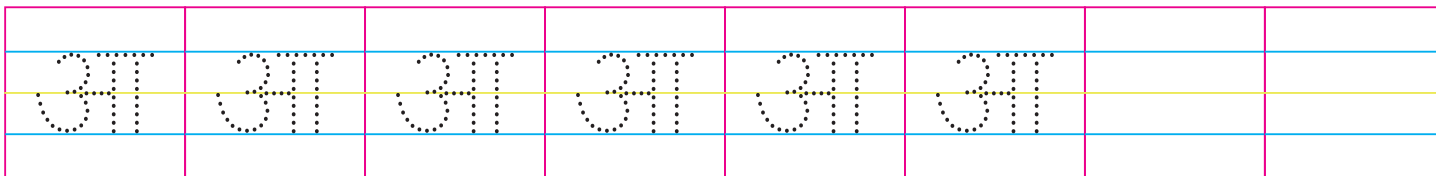
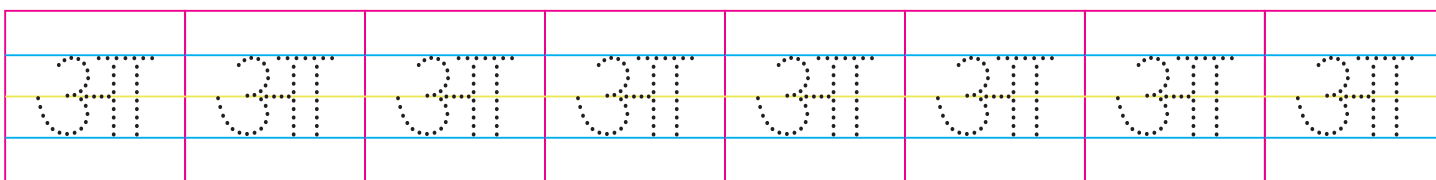

दिए गए चित्र में रंग भरिए-

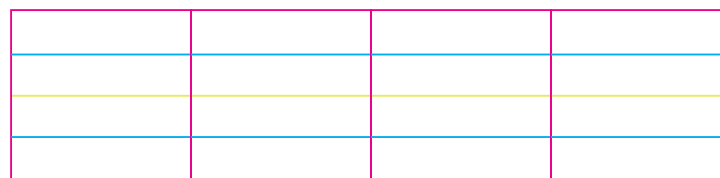
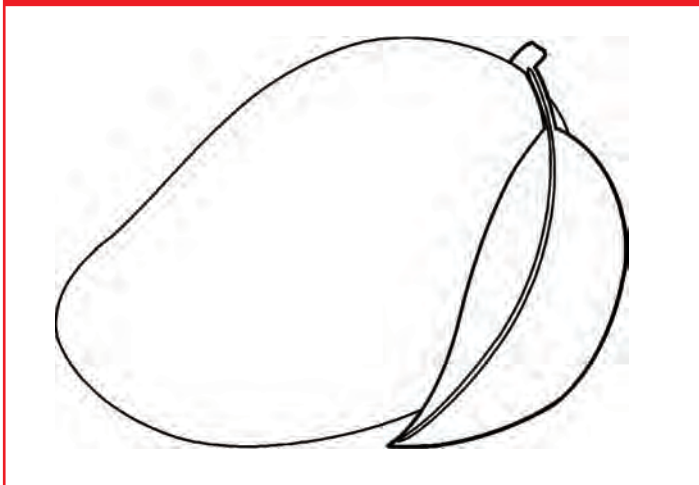

दिनांक:

हस्ताक्षर:

दिनांक



इनाम

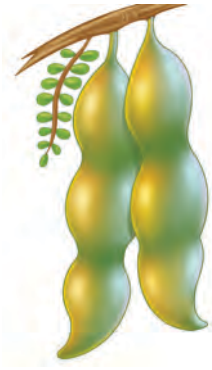
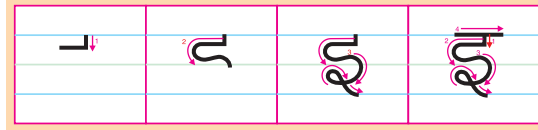
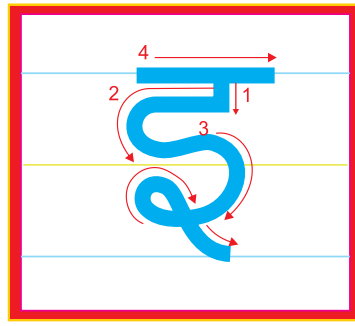

इमली

अभ्यास कीजिए-

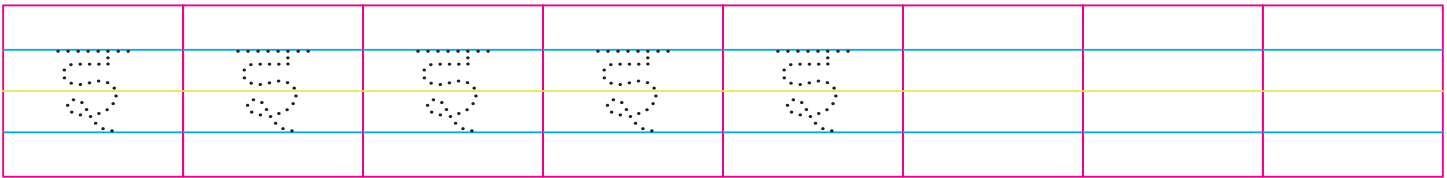
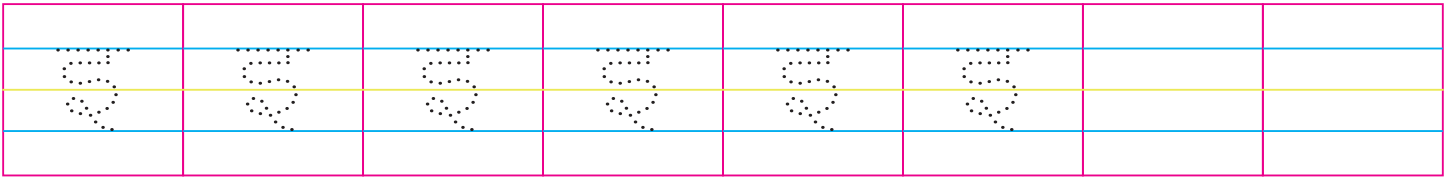
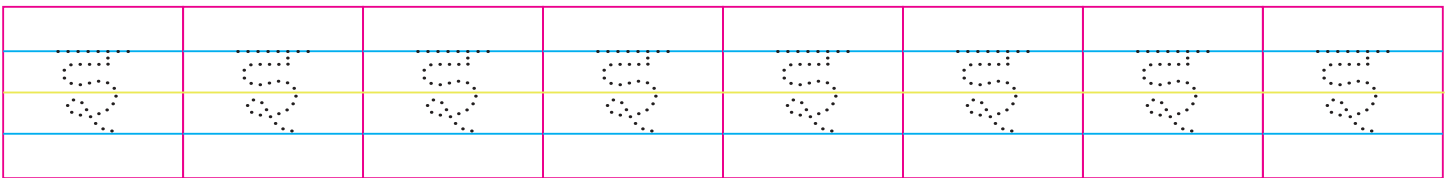

चित्र के प्रथम अक्षर पर सही का निशान लगाइए-

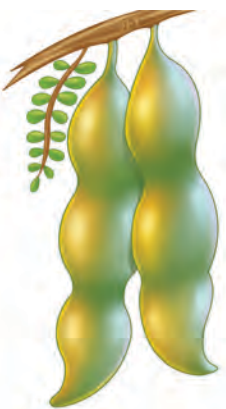

अ

इ

आ

दिनांक:

हस्ताक्षर:

दिनांक



ई

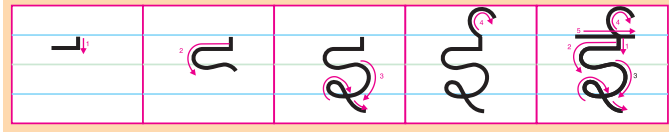
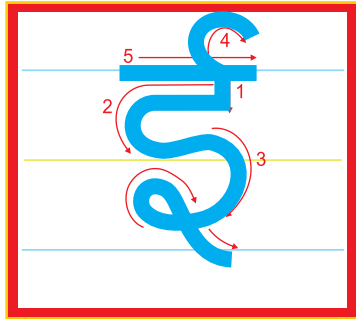

ईख

अभ्यास कीजिए-

दिए गए चित्र में रंग भरिए-

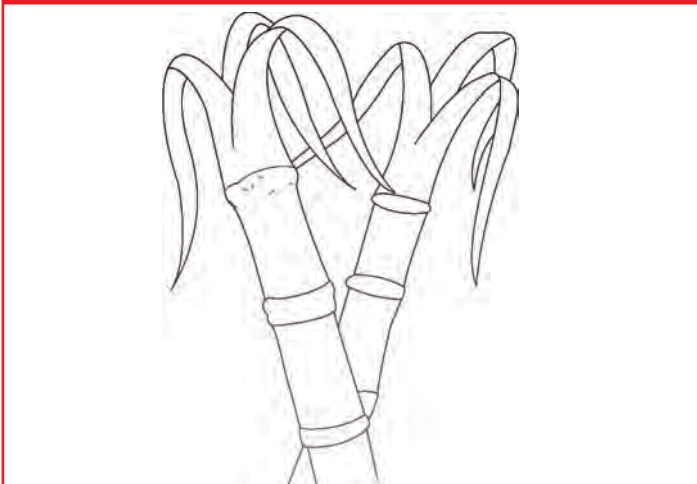

दिनांक:

हस्ताक्षर:

दिनांक



उपहार

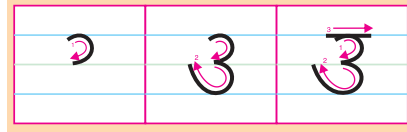
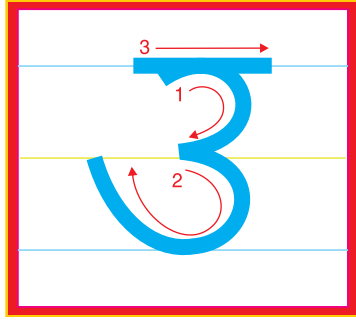

उल्लू

अभ्यास कीजिए-

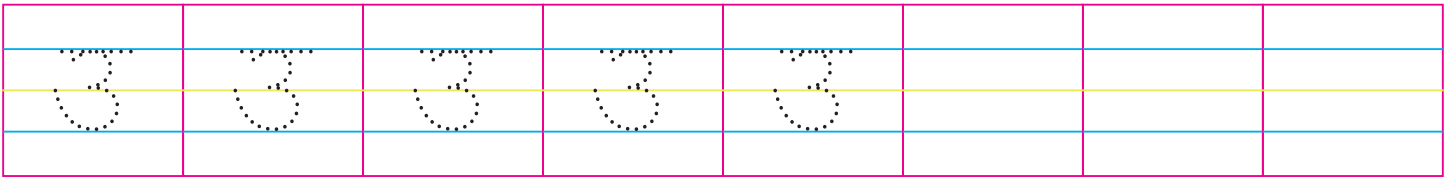
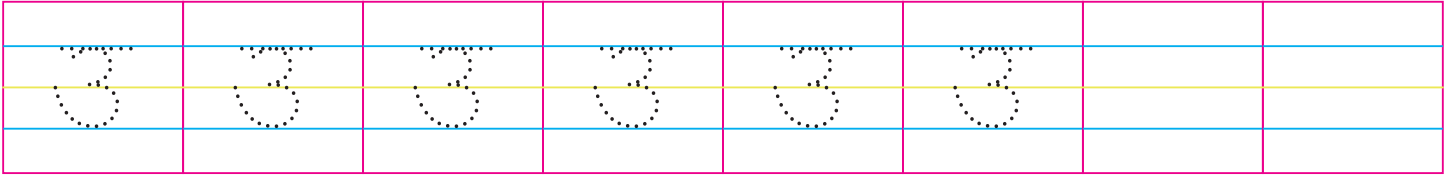
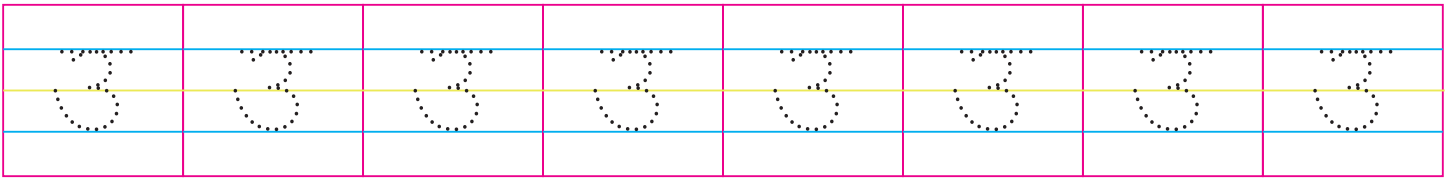

दिए गए चित्र में रंग भरिए-

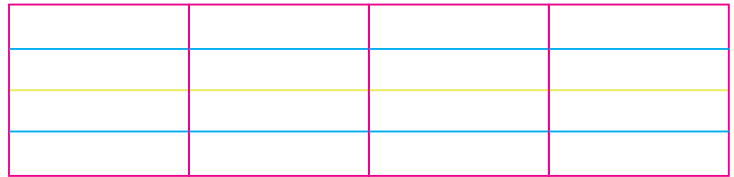
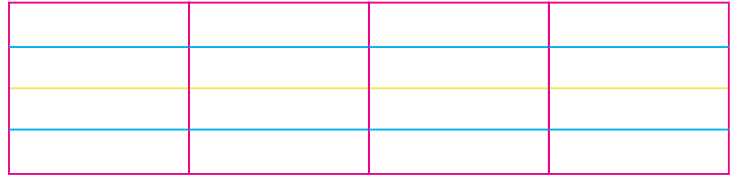

दिनांक:

हस्ताक्षर:

दिनांक



ऊन

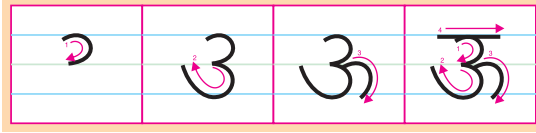
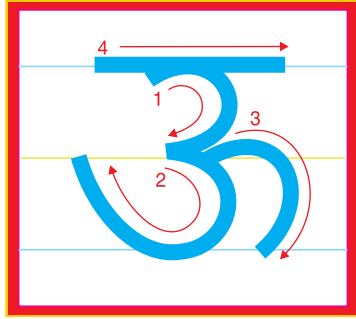

ऊँट

अभ्यास कीजिए-

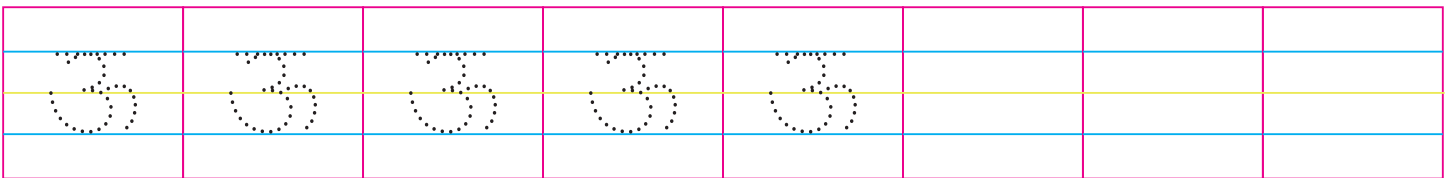
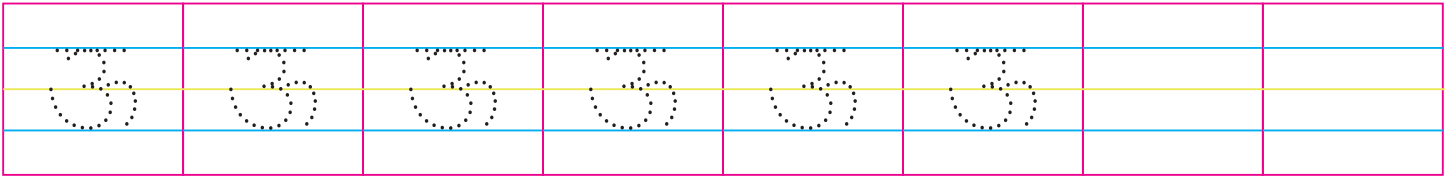
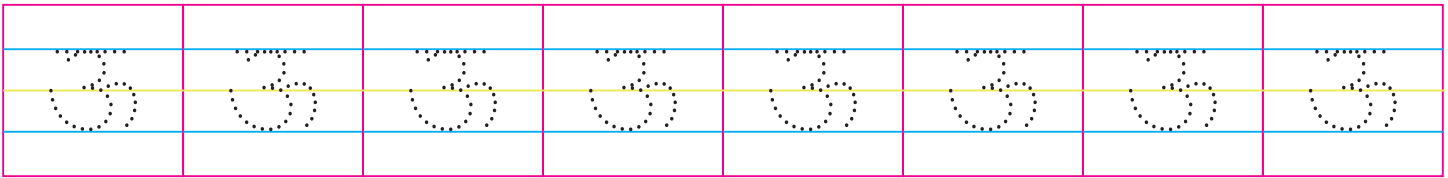

दिए गए चित्र में रंग भरिए-

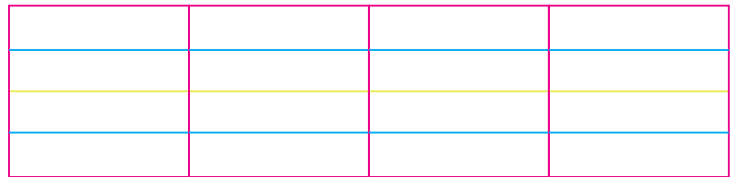
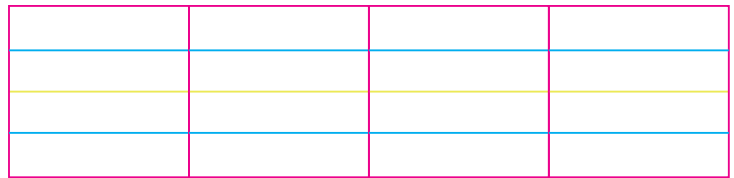
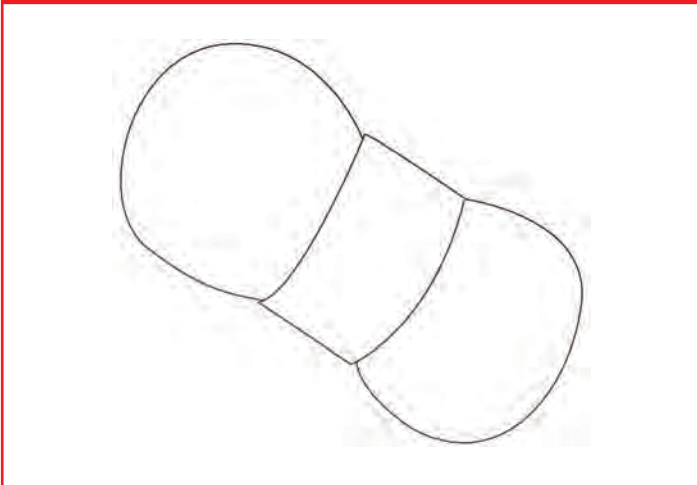

दिनांक:

7

अक्षर रचना

हस्ताक्षर:

दिनांक



ऋषभ

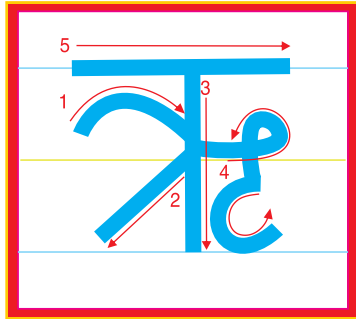

ऋषि

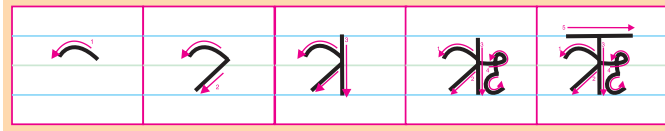

अभ्यास कीजिए-

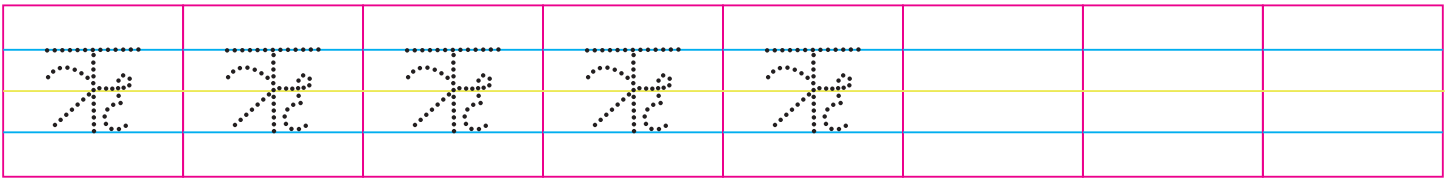
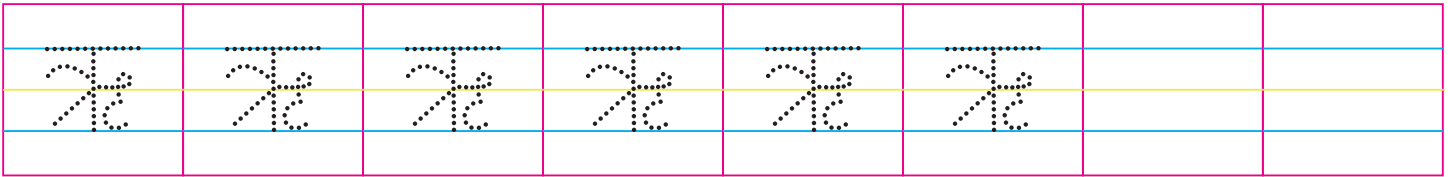
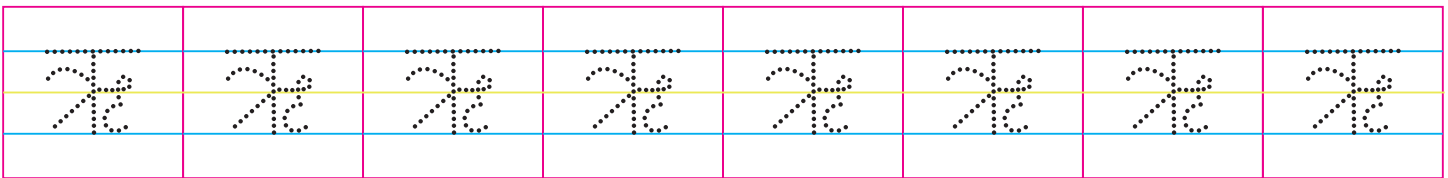

चित्र के प्रथम अक्षर पर सही का निशान लगाइए-



ऋ

ए

उ

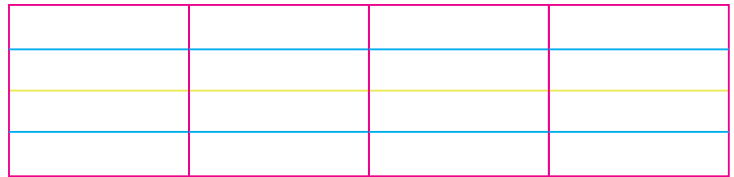
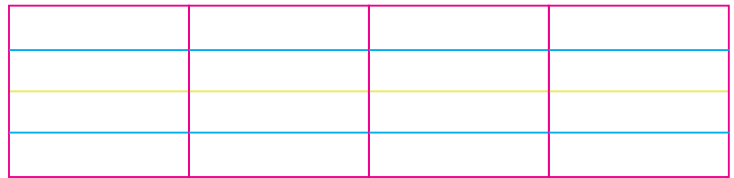

दिनांक:

हस्ताक्षर:

दिनांक

अभ्यास

चित्रों का सही अक्षर से मिलान कीजिए -



इ



अ



ऋ



उ



आ



ई

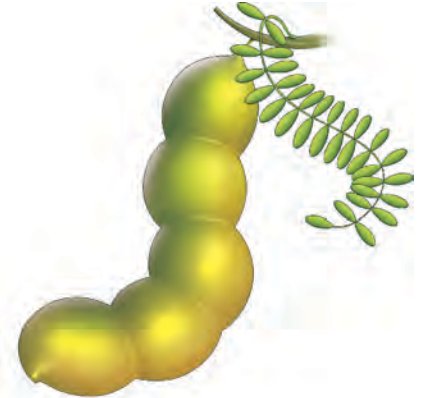

ऊ

दिनांक:

9

अक्षर रचना

हस्ताक्षर:

दिनांक

1

एक

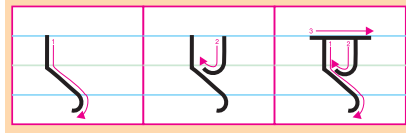
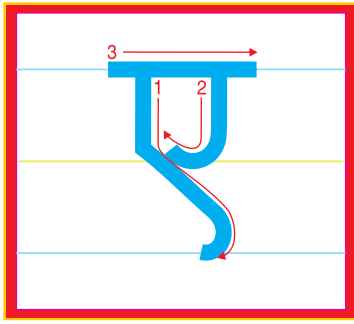

एड़ी

अभ्यास कीजिए-

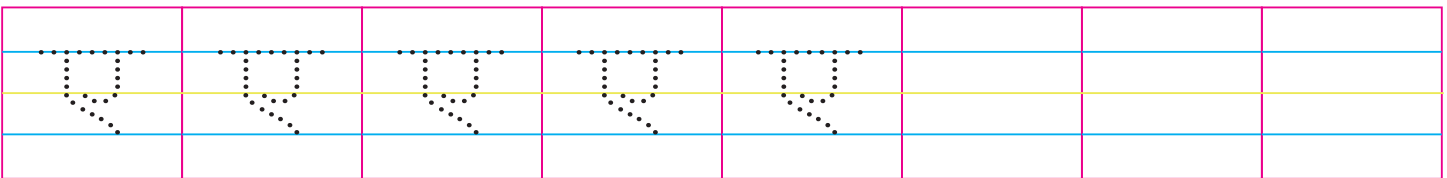
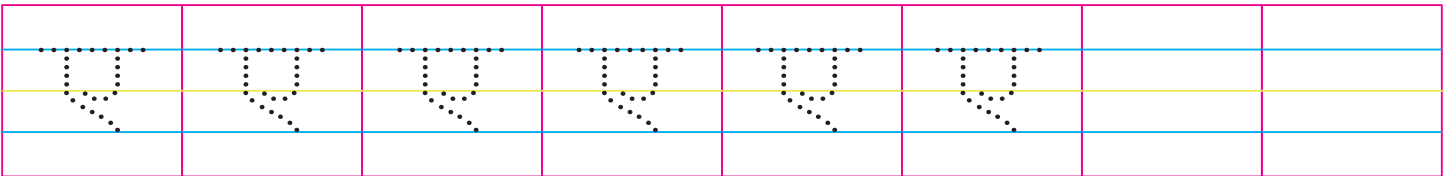
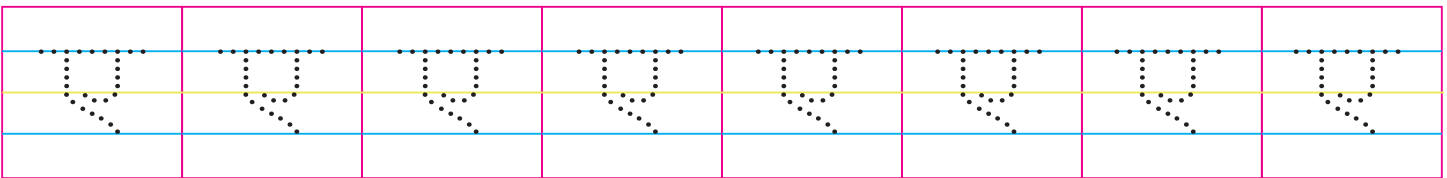

दिए गए चित्र में रंग भरिए-

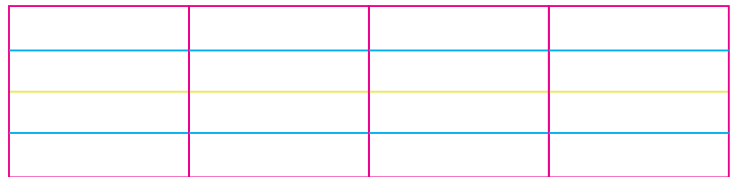
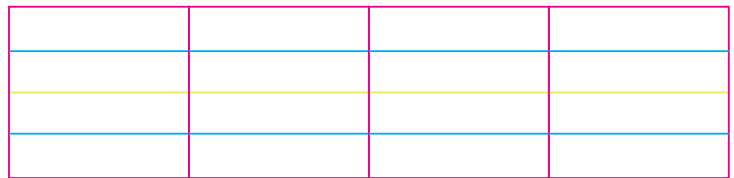

दिनांक:

हस्ताक्षर:

दिनांक



ऐरावत

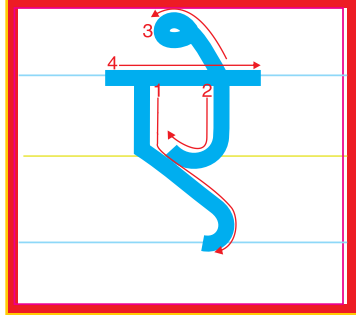

ऐनक

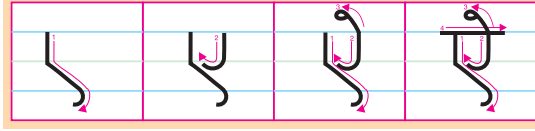

अभ्यास कीजिए-

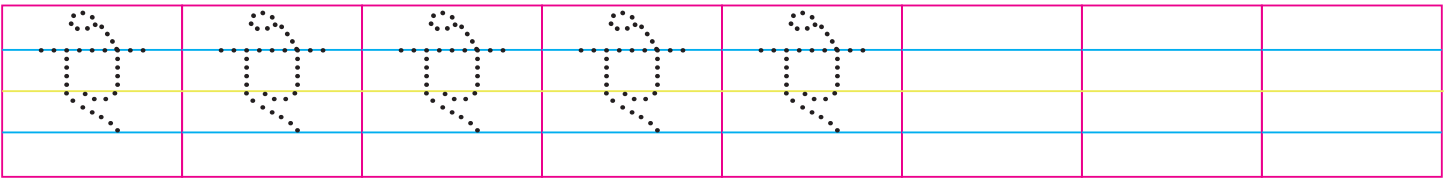
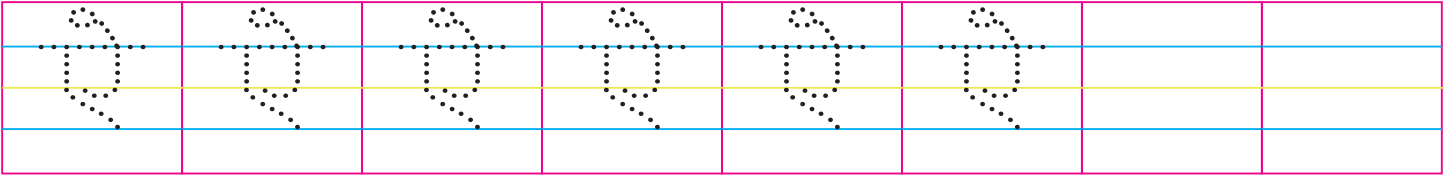
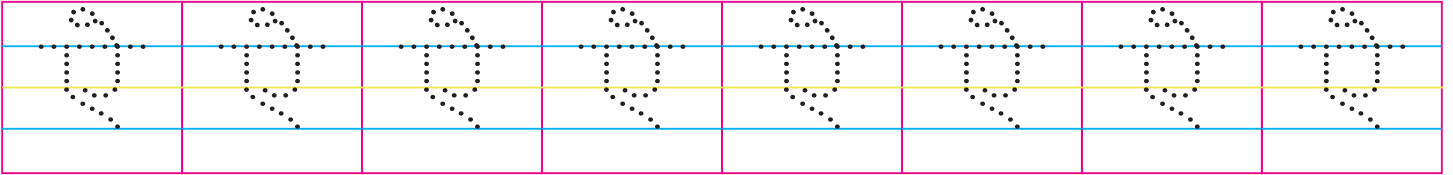

चित्र पहचानकर पहला अक्षर लिखिए
व रंग भरिए-

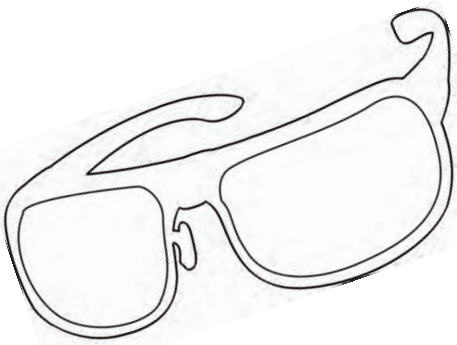

दिनांक:

हस्ताक्षर:

दिनांक



ओढ़नी

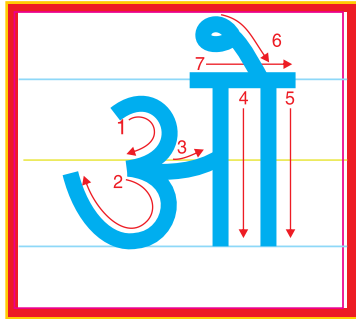

ओखली

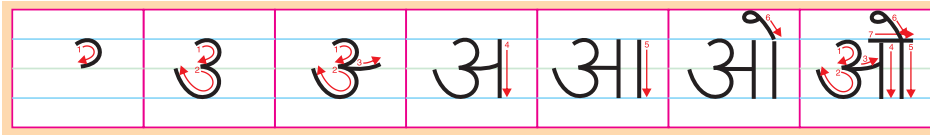

अभ्यास कीजिए-

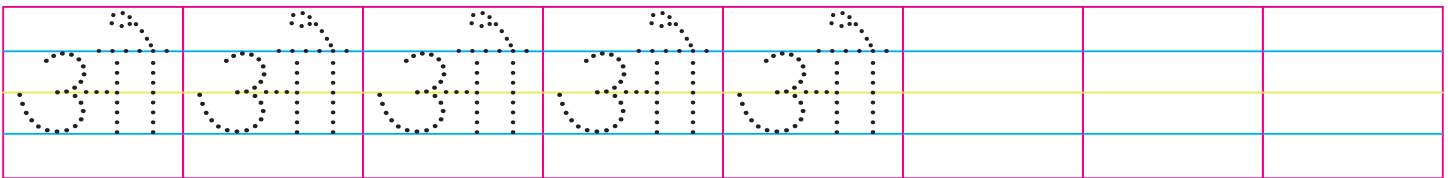
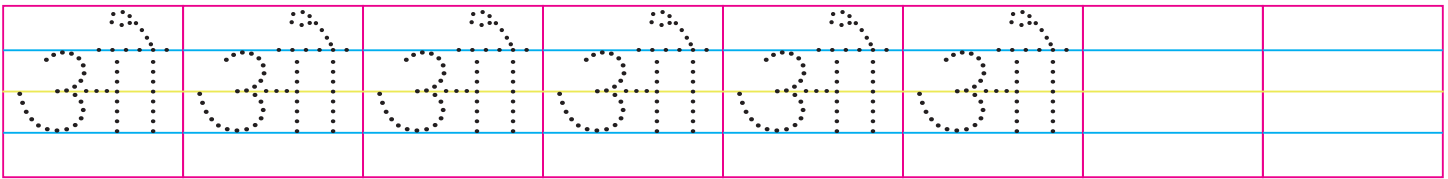
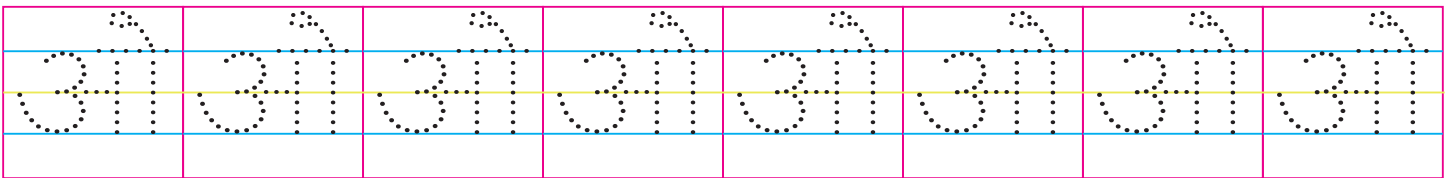

चित्र के प्रथम अक्षर पर सही का निशान लगाइए-



अ

ओ

आ

दिनांक:

हस्ताक्षर:

दिनांक



औषधि

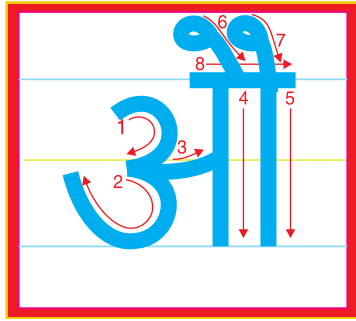

औरत

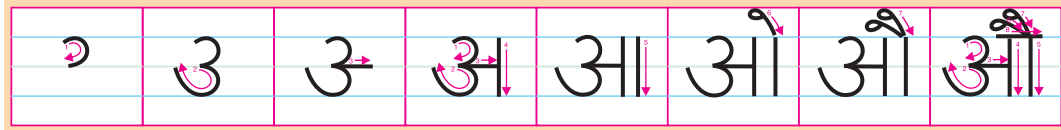

अभ्यास कीजिए-

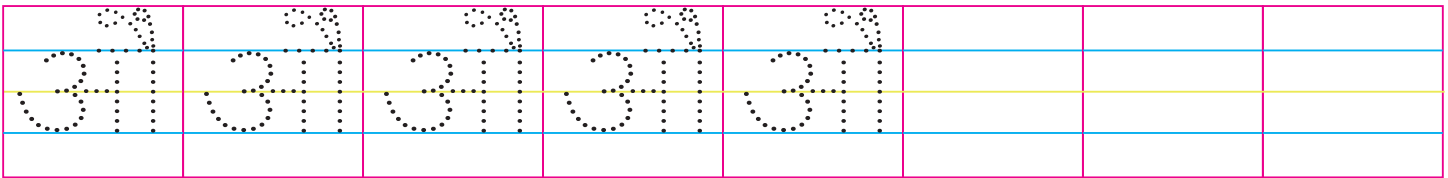
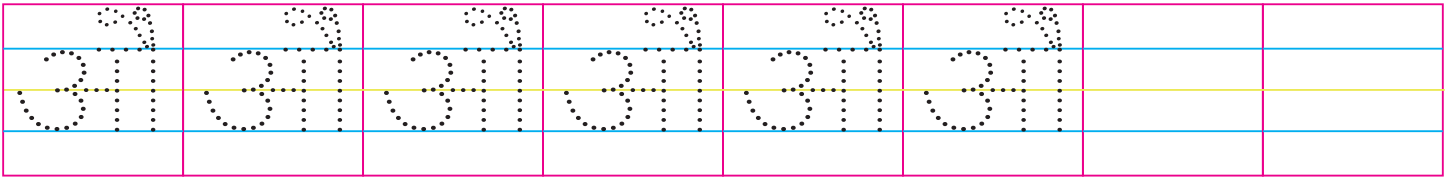
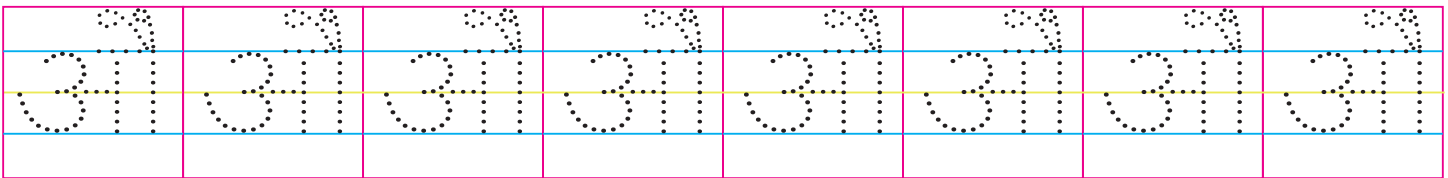

दिए गए चित्र में रंग भरिए-

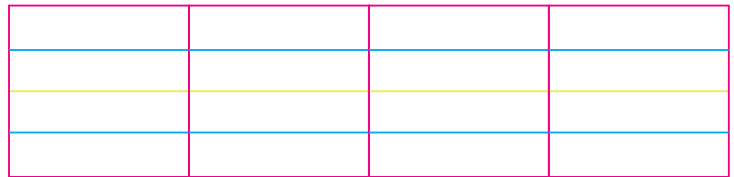
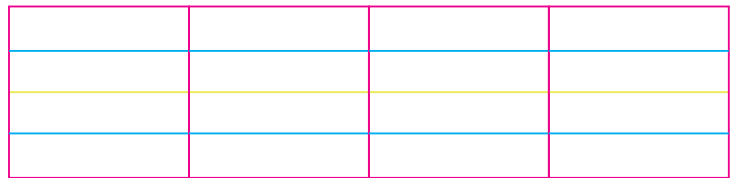

दिनांक:

हस्ताक्षर:

दिनांक



अंगूठी

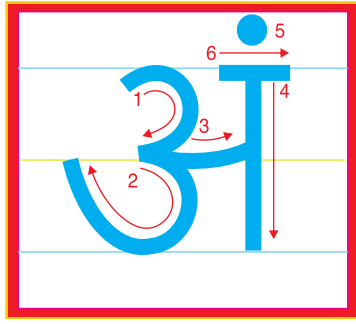

अंगूर

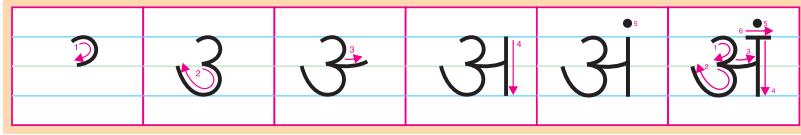

अभ्यास कीजिए-

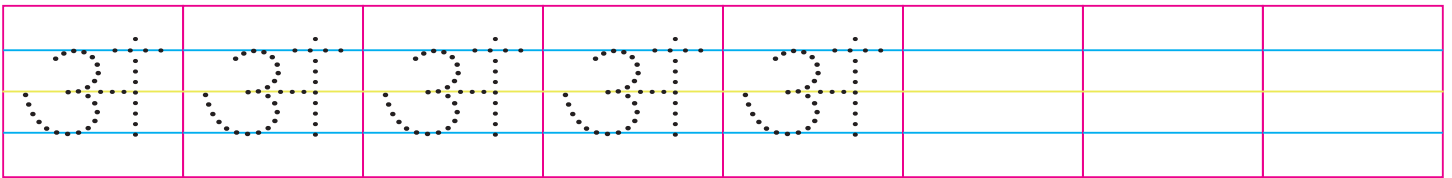
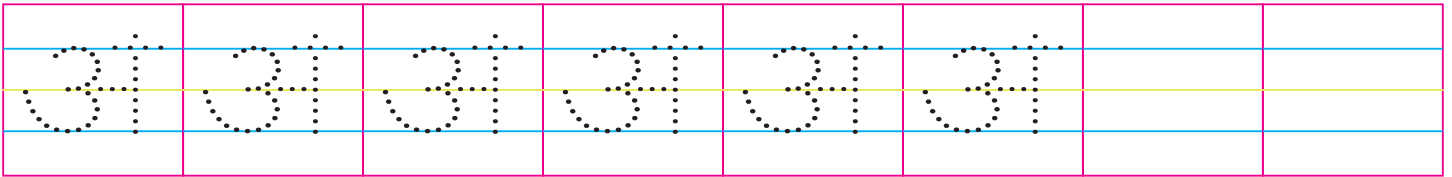
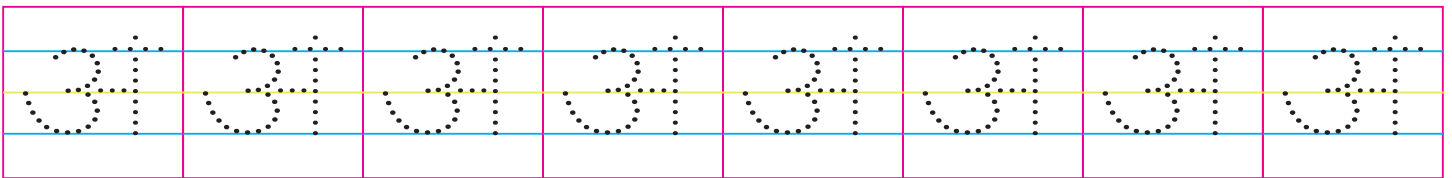

दिए गए चित्र में रंग भरिए-

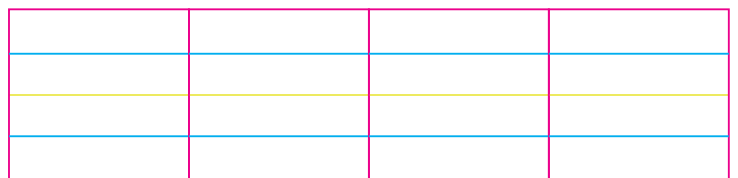
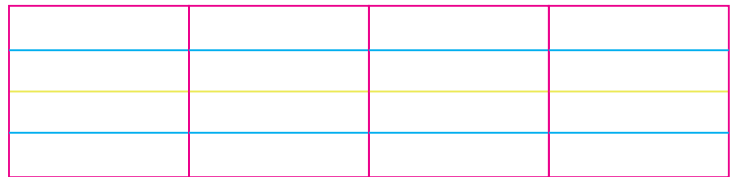
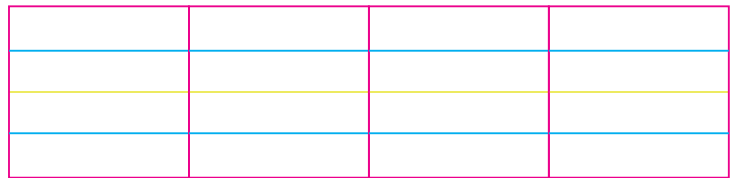
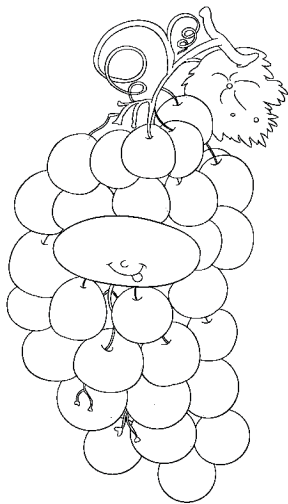

दिनांक:

हस्ताक्षर:

दिनांक

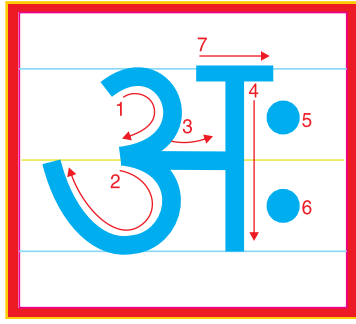

अः

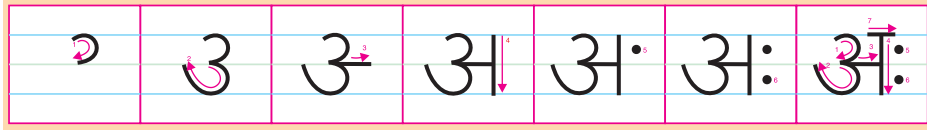

अभ्यास कीजिए-

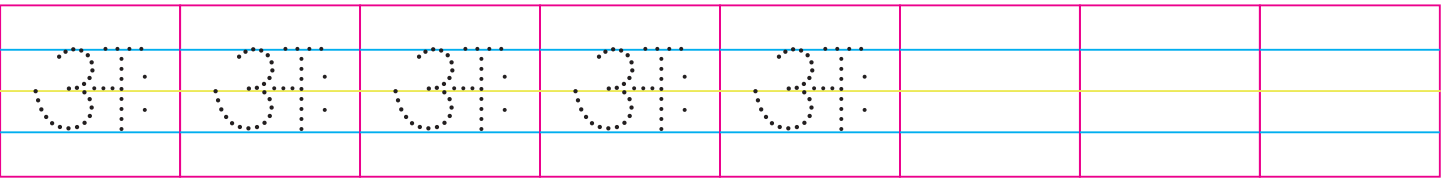
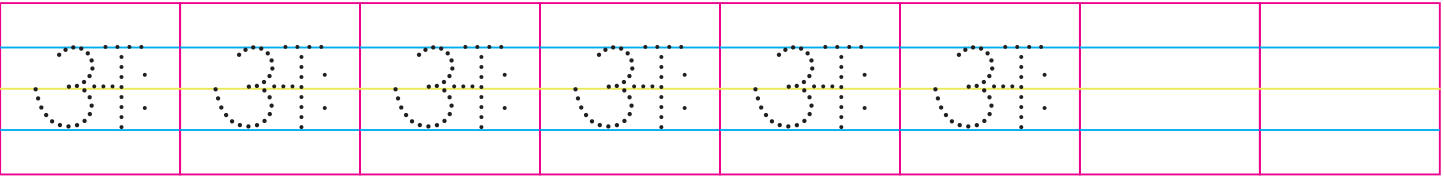
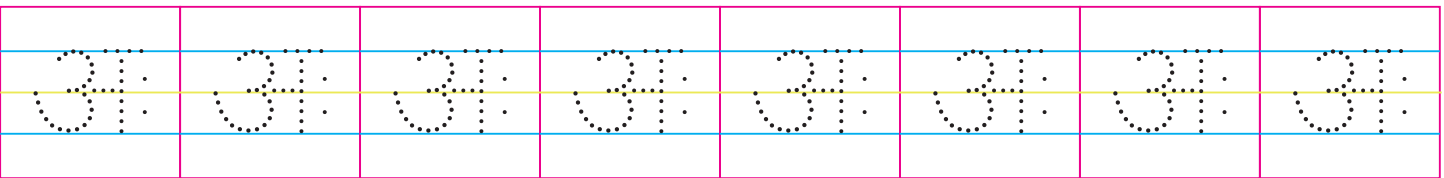

चित्र पहचानकर उसका पहला अक्षर लिखिए-

	<input type="text"/>		<input type="text"/>
	<input type="text"/>		<input type="text"/>
	<input type="text"/>		<input type="text"/>

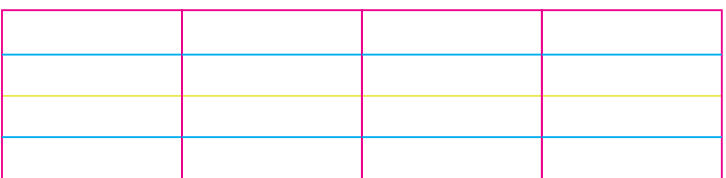
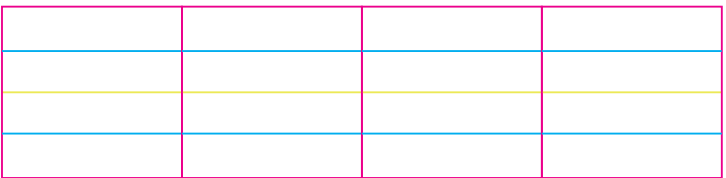

दिनांक:

हस्ताक्षर:







दिनांक

रिक्त स्थान भरिए-

अ इ उ

ए ओ अः

चित्र को पहचानकर अक्षर से मिलान करो-

ऐ		ए		इ	
ऋ		अं		औ	
ऊ		उ		अ	
ओ		ई		आ	

दिनांक:

16

अक्षर रचना

हस्ताक्षर:

दिनांक



कछुआ

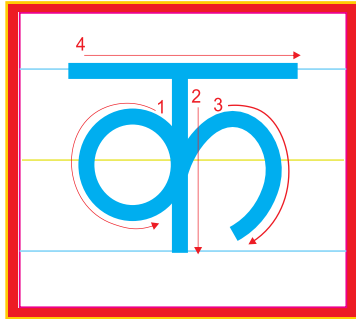

कबूतर

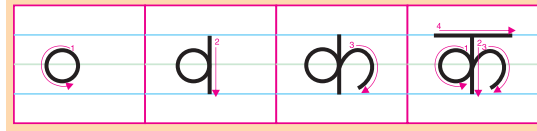

अभ्यास कीजिए-

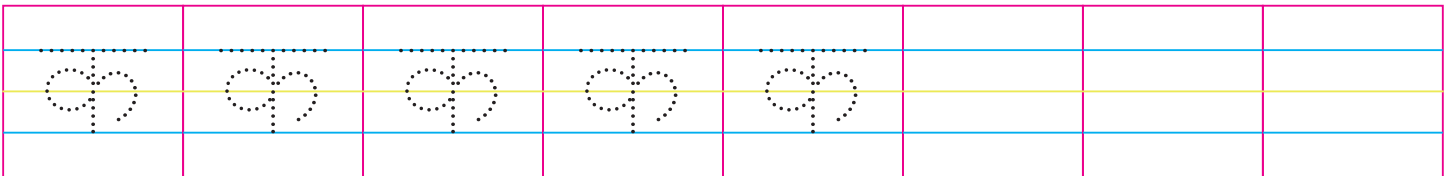
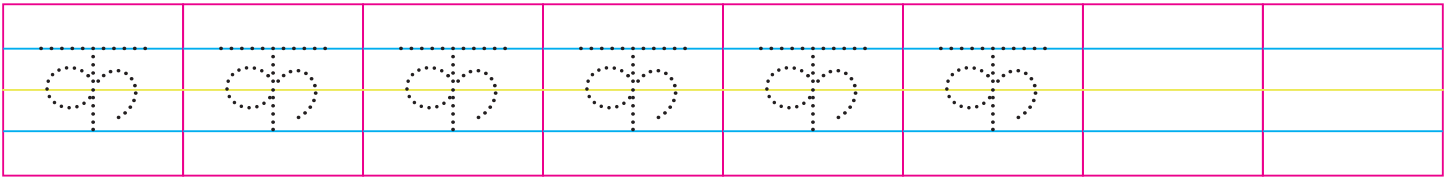
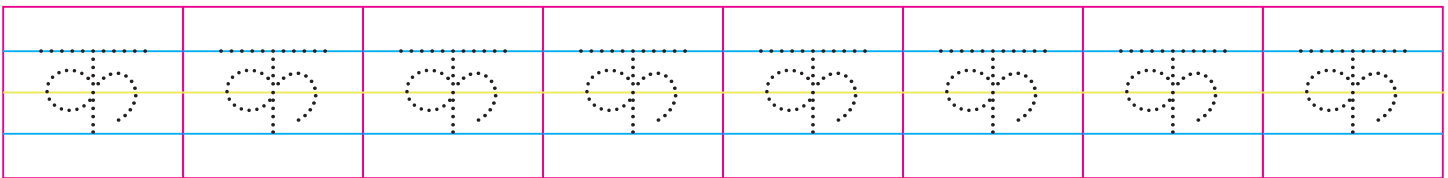

चित्र पहचानकर पहला अक्षर लिखिए व रंग भरिए-

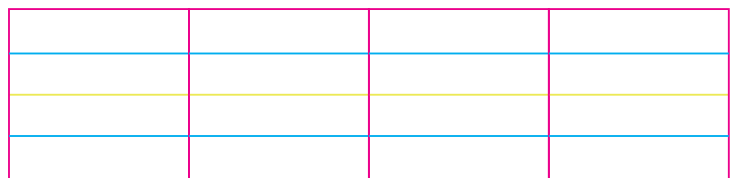
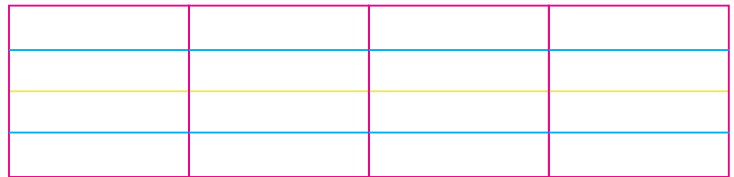
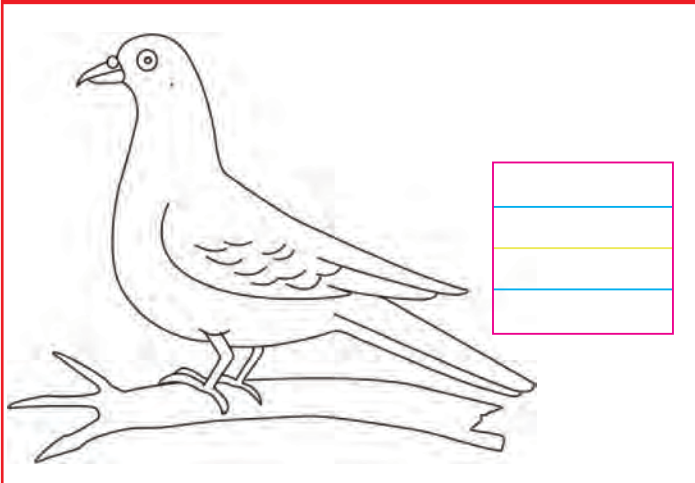

दिनांक:

हस्ताक्षर:

दिनांक



खरबूजा

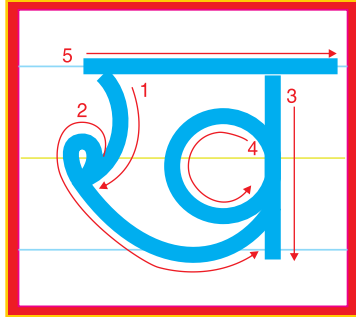

खरगोश

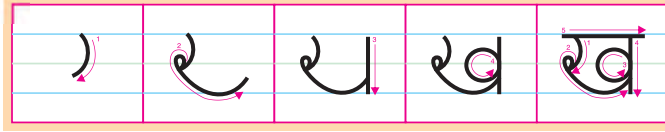

अभ्यास कीजिए-

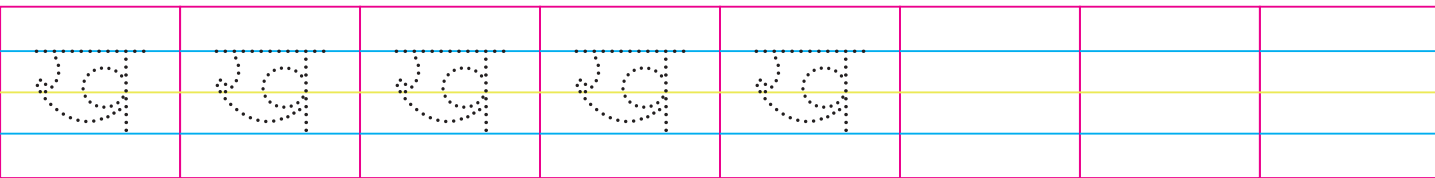
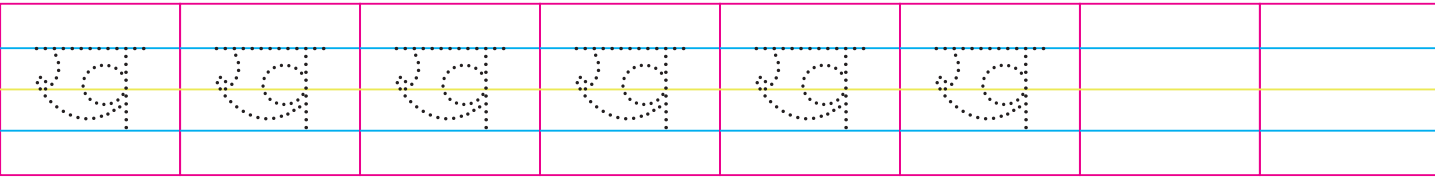
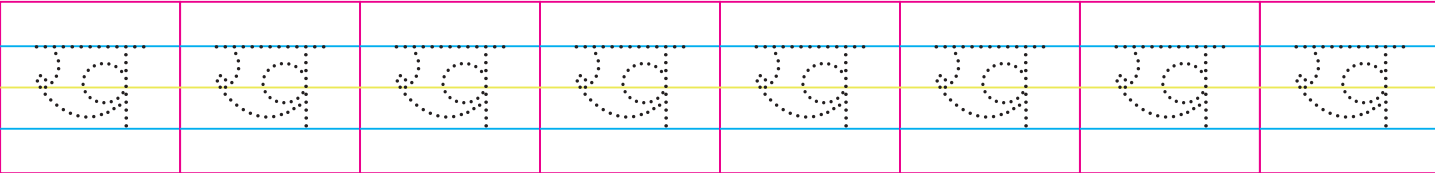

दिए गए चित्र में रंग भरिए-



दिनांक:

हस्ताक्षर:

दिनांक



गधा

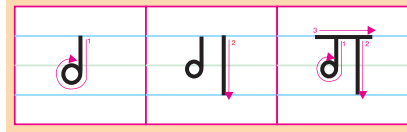
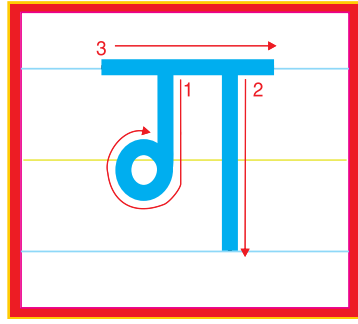

गमला



अभ्यास कीजिए-

ग ग ग ग ग ग ग ग

ग ग ग ग ग ग

ग ग ग ग ग

चित्र के प्रथम अक्षर पर सही का निशान लगाइए-



ग

क

आ

--	--	--	--

--	--	--	--

--	--	--	--

दिनांक:

हस्ताक्षर:

दिनांक



घड़ी

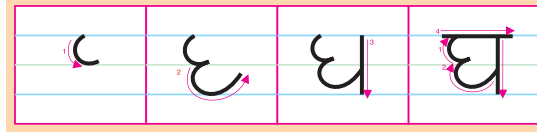
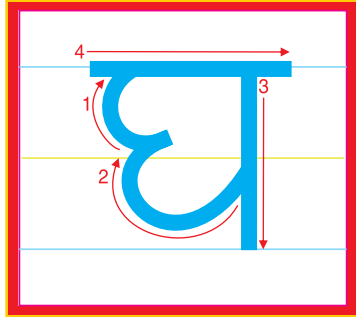

घर

अभ्यास कीजिए-

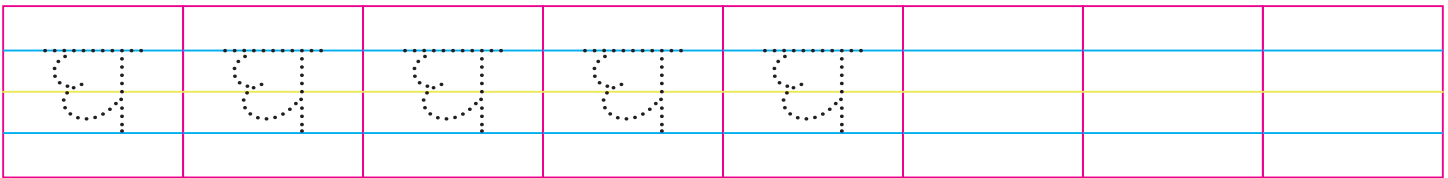
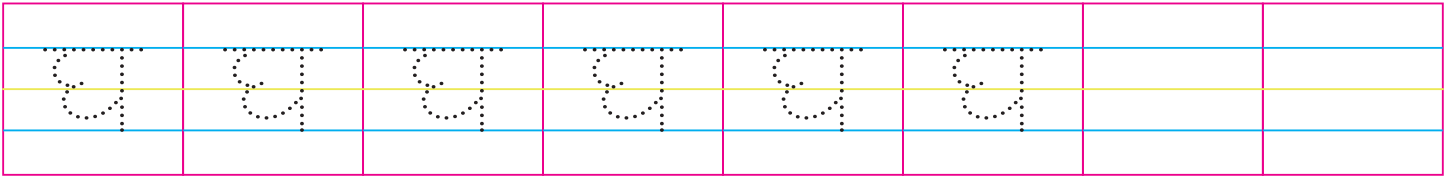
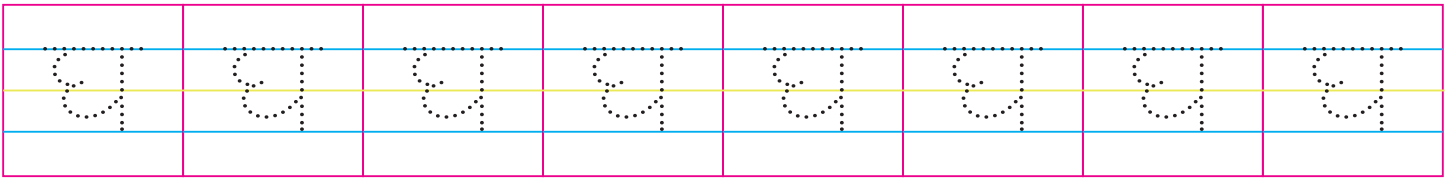

दिए गए चित्र में रंग भरिए-

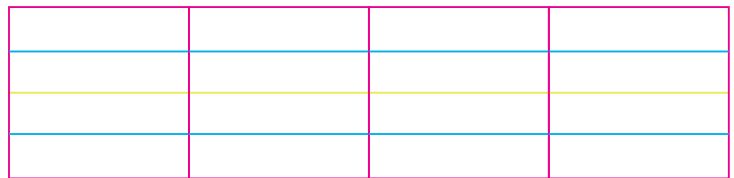
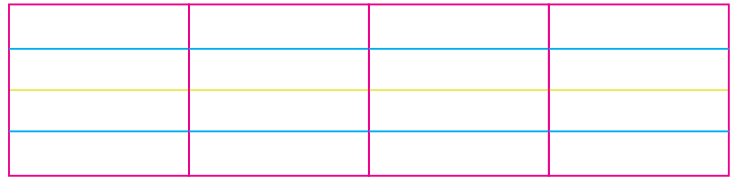
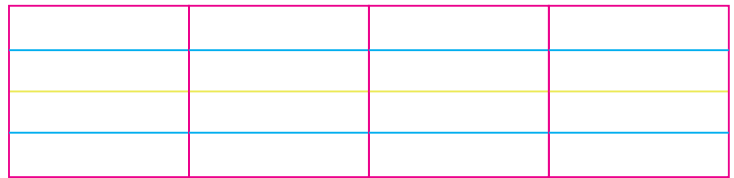

दिनांक:

हस्ताक्षर:



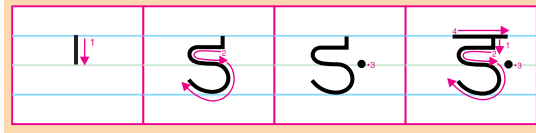
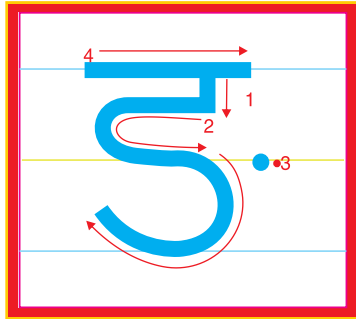

दिनांक

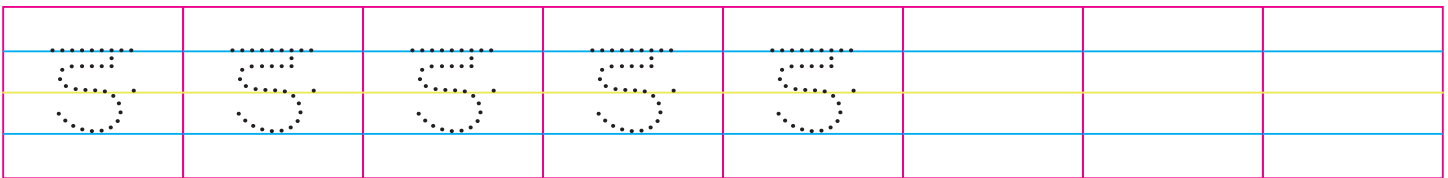
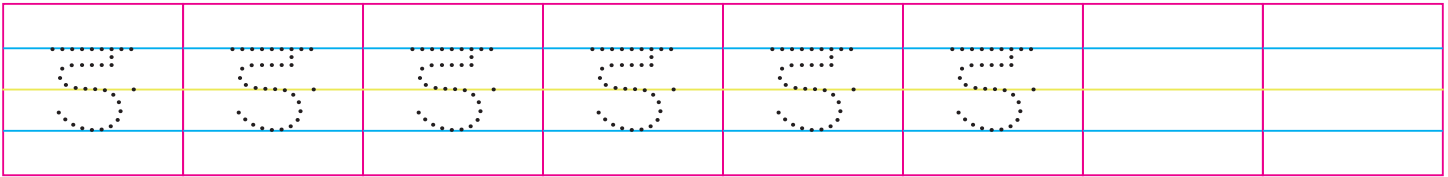
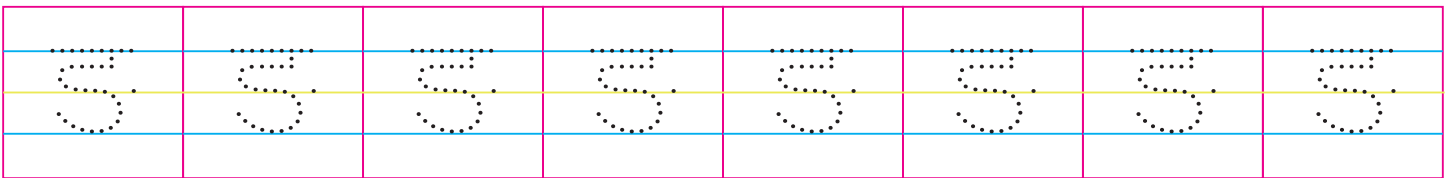

अभ्यास कीजिए-



चित्र पहचानकर उनके नाम का पहला अक्षर लिखिए-

	<input type="text"/>		<input type="text"/>
	<input type="text"/>		<input type="text"/>

दिनांक:

हस्ताक्षर:

दिनांक

नीचे दिए गए चित्रों में रंग भरिए और इनके प्रथम वर्ण लिखिए—

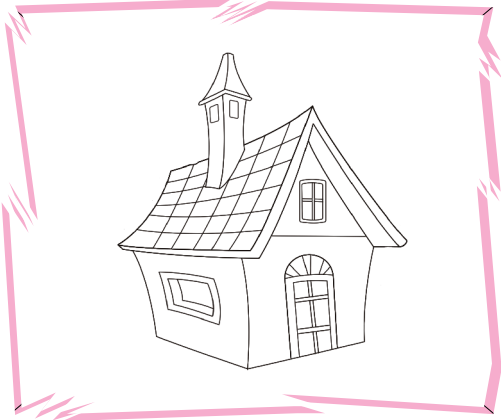

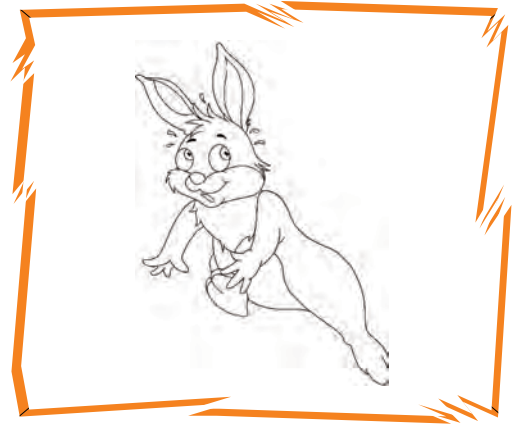



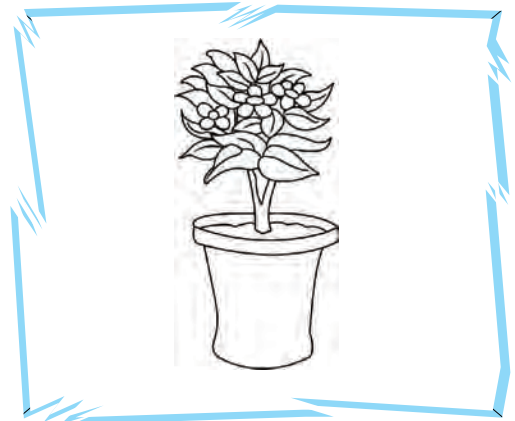

दिनांक:

हस्ताक्षर:

दिनांक



चरखा

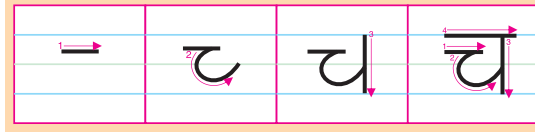
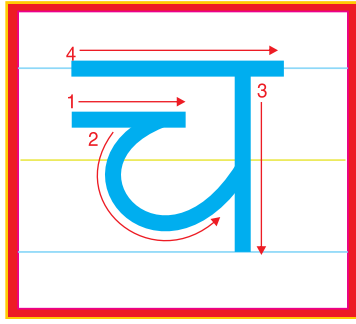

चम्मच

अभ्यास कीजिए-

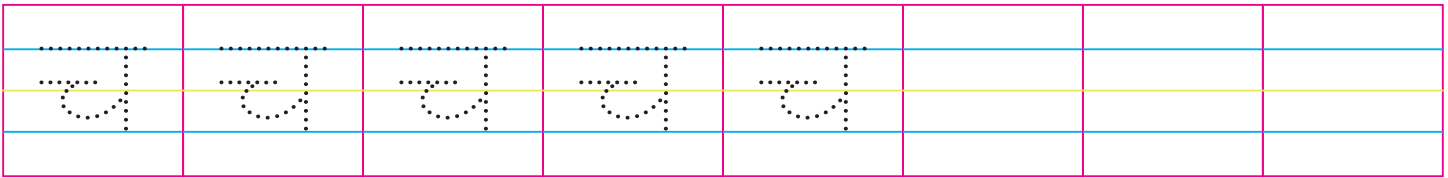
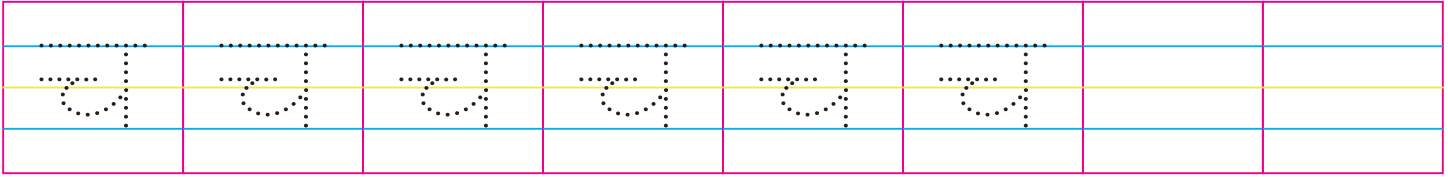
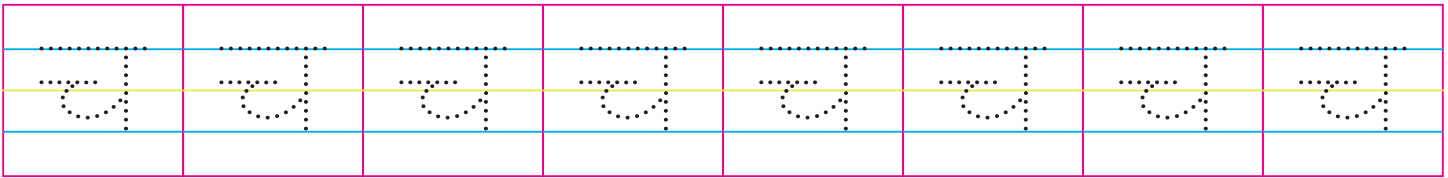

चित्र पहचानकर पहला अक्षर लिखिए व रंग भरिए-

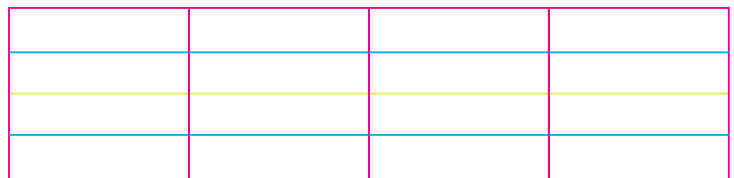
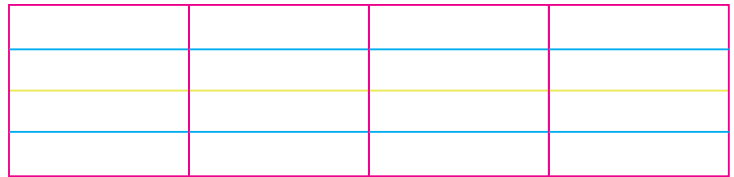
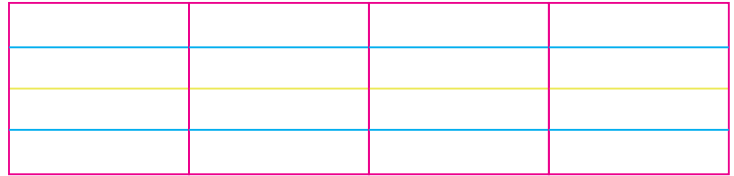
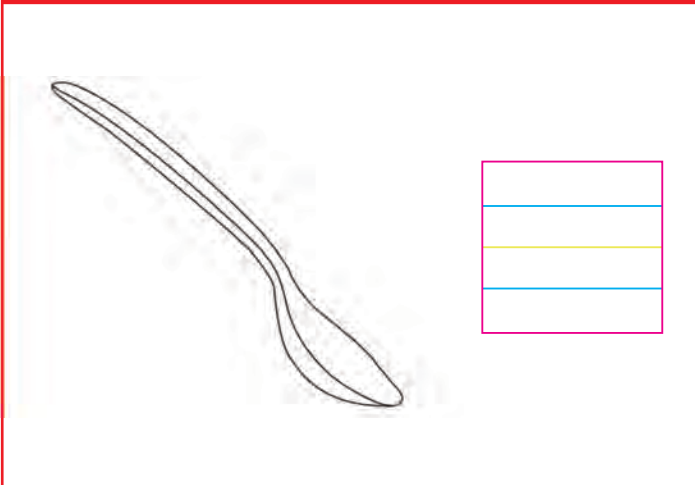

दिनांक:

हस्ताक्षर:

दिनांक



छड़ी

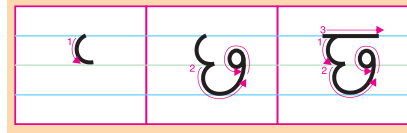
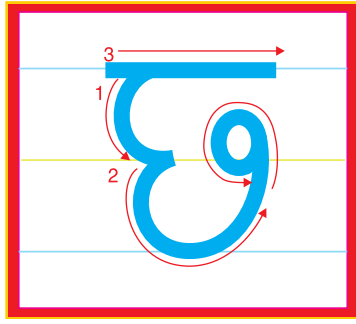

छतरी

अभ्यास कीजिए-

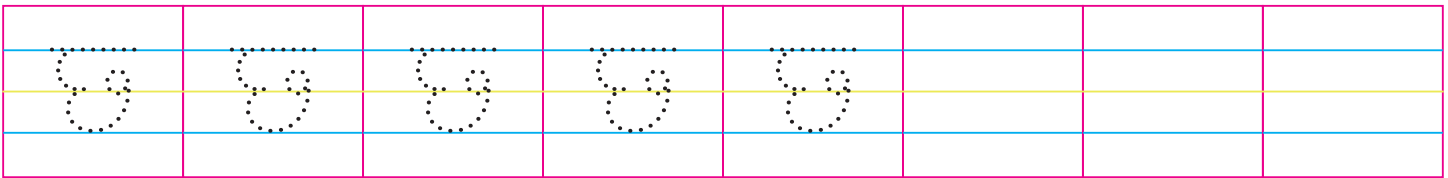
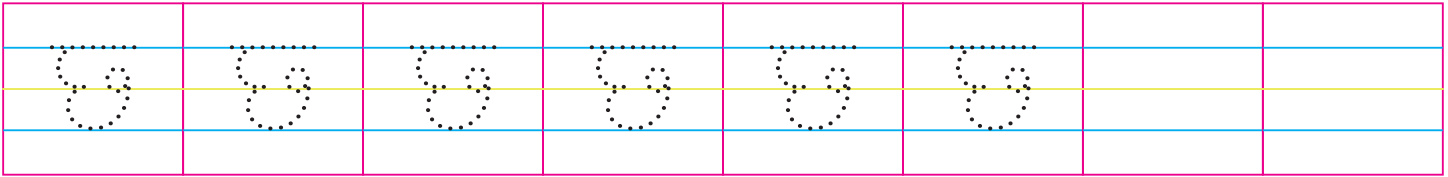
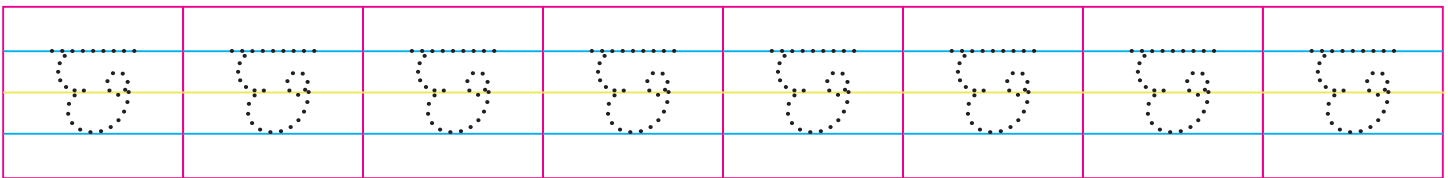

दिए गए चित्र में रंग भरिए-

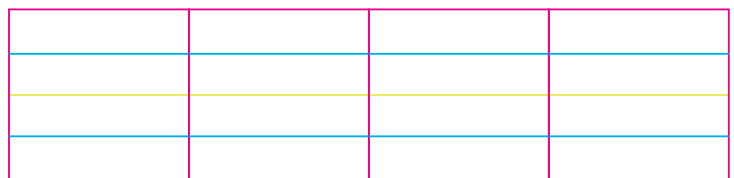
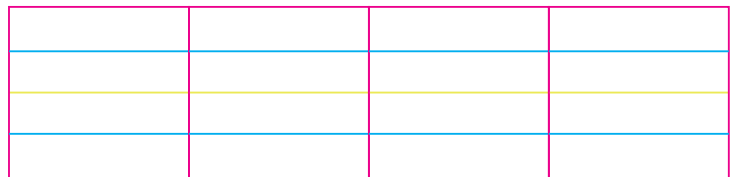
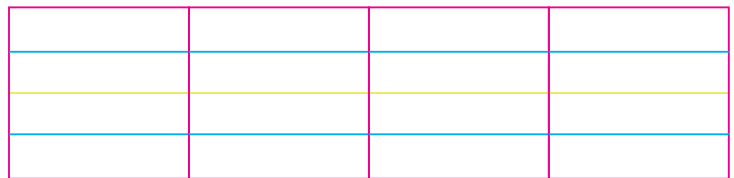

दिनांक:

हस्ताक्षर:

दिनांक



जग

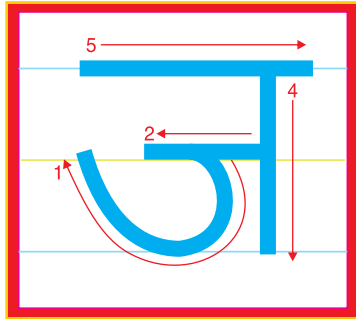

जहाज़

अभ्यास कीजिए-

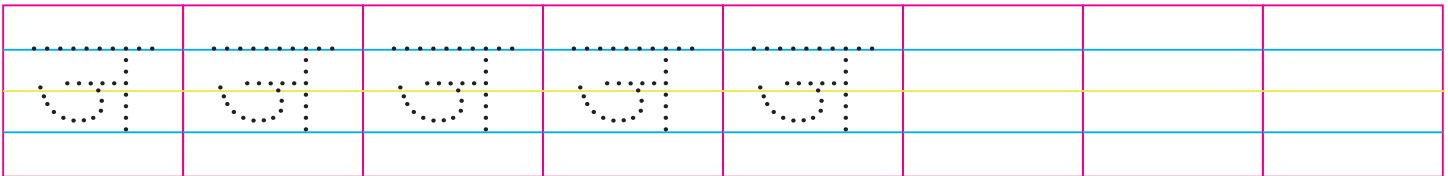
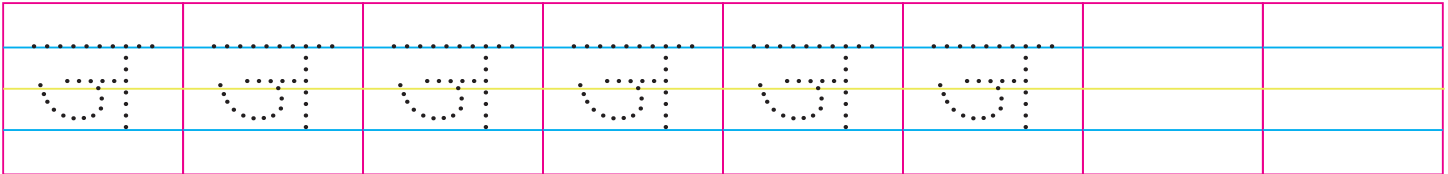
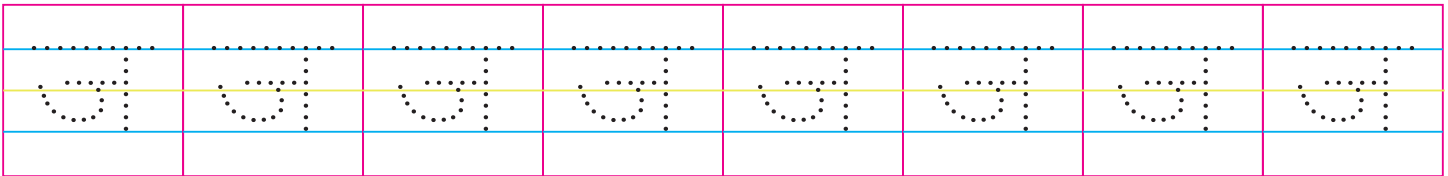

दिए गए चित्र में रंग भरिए-

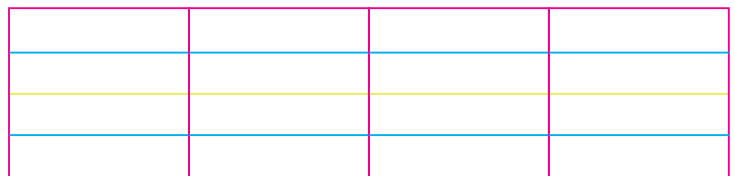
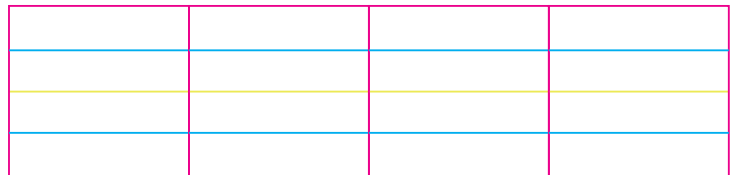
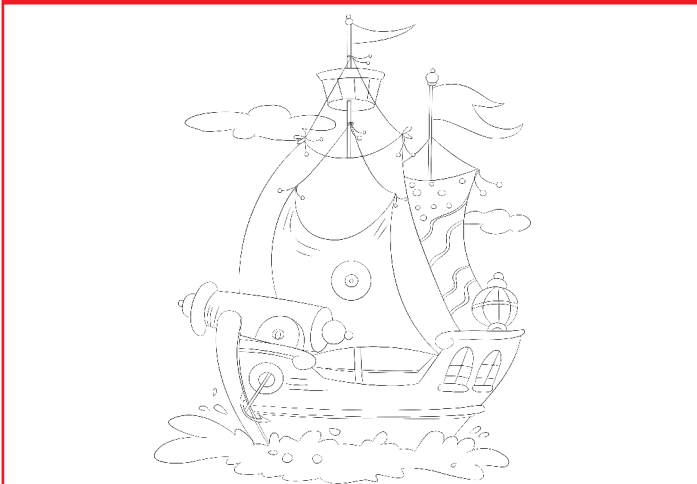

दिनांक:

हस्ताक्षर:

दिनांक



झरना

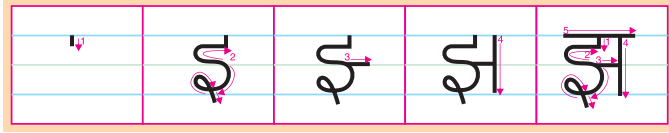
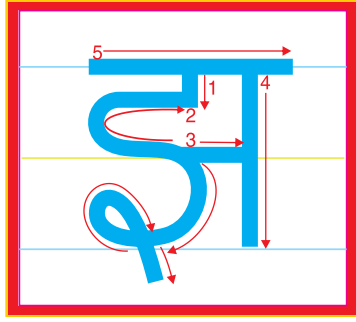

झंडा

अभ्यास कीजिए-

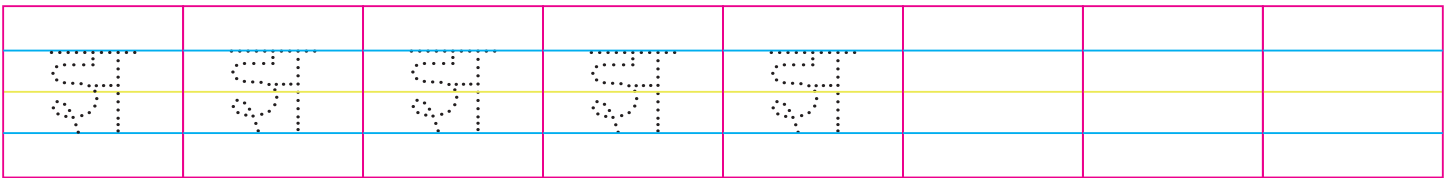
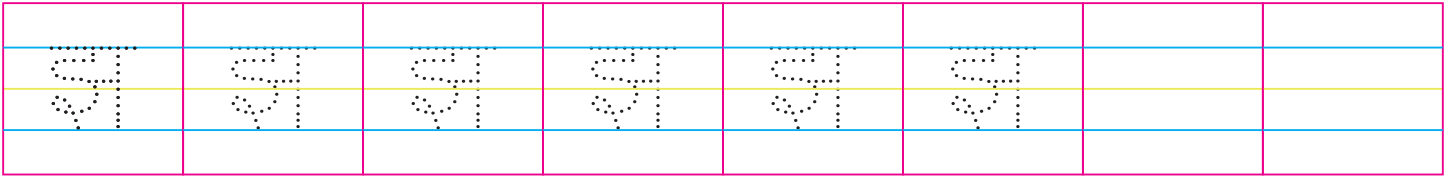
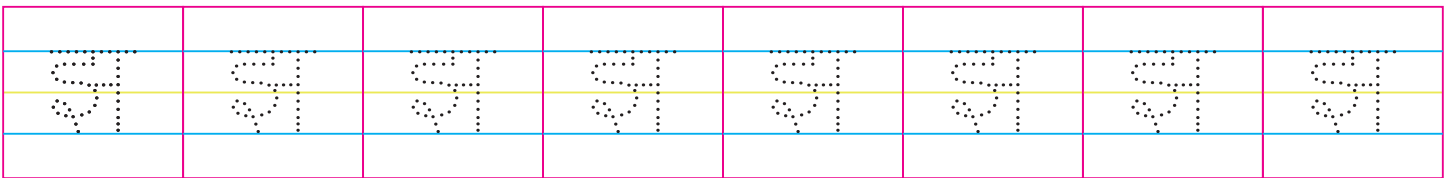

चित्र के प्रथम अक्षर पर सही का निशान लगाइए-



च

झ

छ

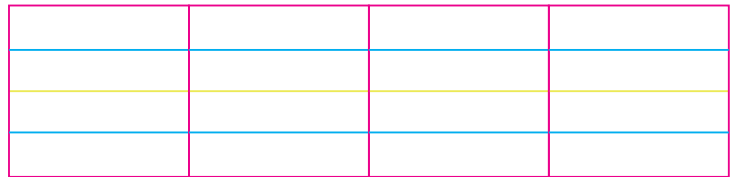
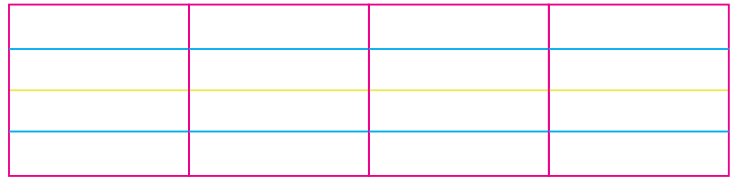

दिनांक:

हस्ताक्षर:

दिनांक



ज

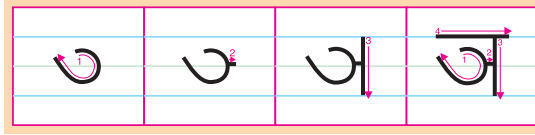
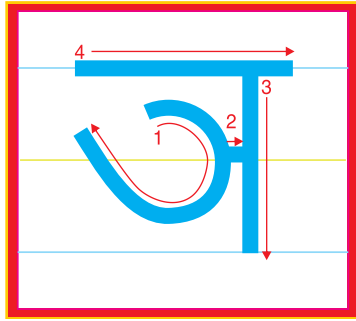

अभ्यास कीजिए-

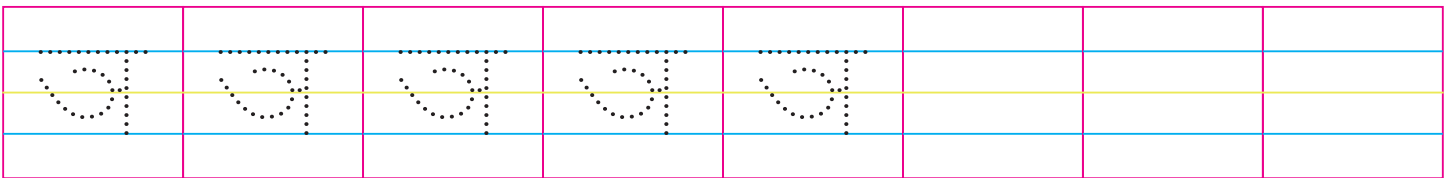
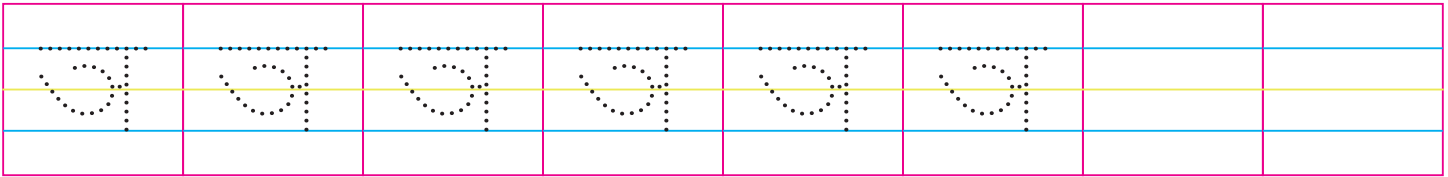
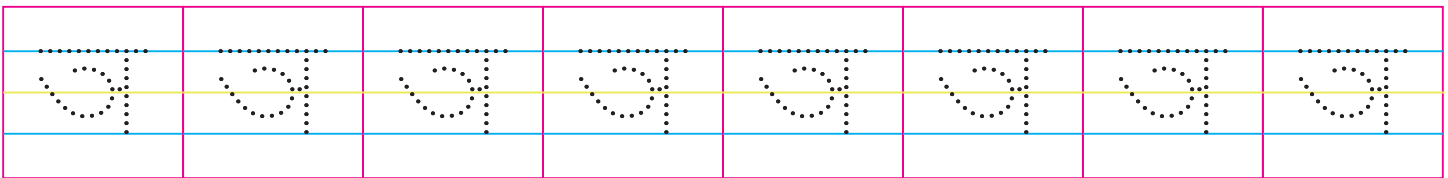

चित्र को उनके प्रथम अक्षर से मिलाओ-



च



छ

ज



झ

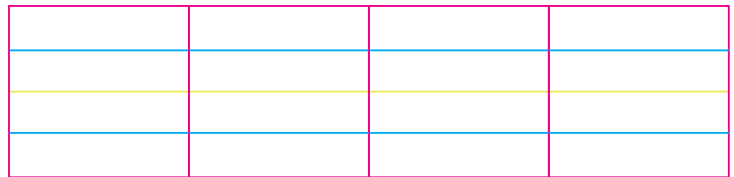
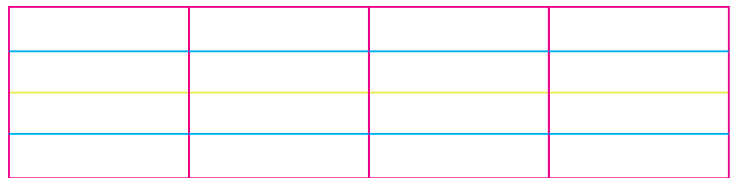

दिनांक:

हस्ताक्षर:

दिनांक

खाली स्थान को भरिए-

क

ग

ङ

छ

झ

चित्र को देखकर उसके नाम का प्रथम अक्षर लिखिए तथा रंग भरिए-

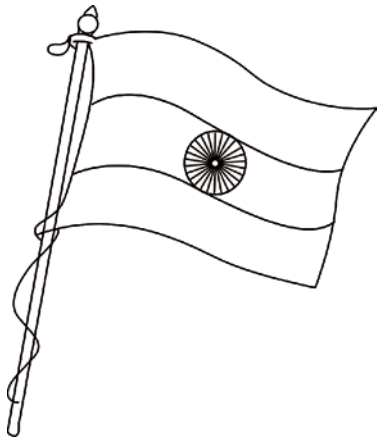

दिनांक:

हस्ताक्षर:

दिनांक



टब

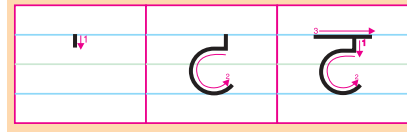
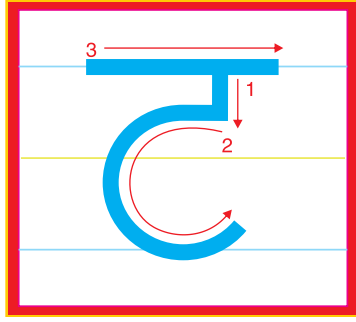

टमाटर

अभ्यास कीजिए-

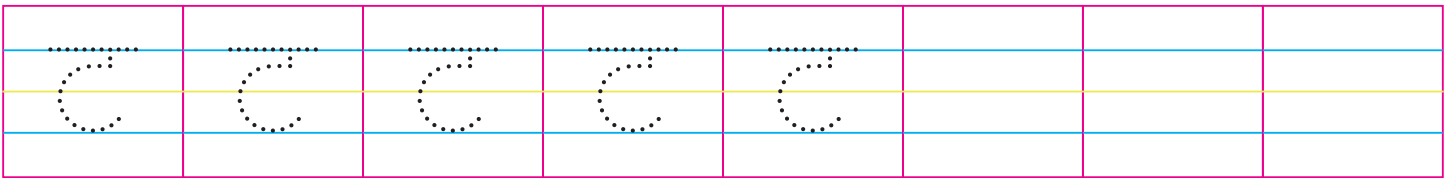
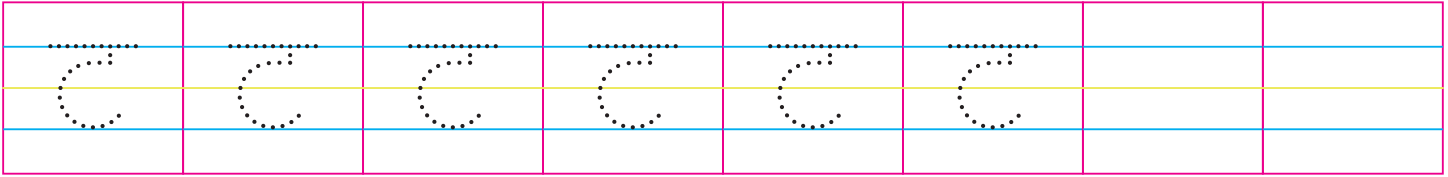
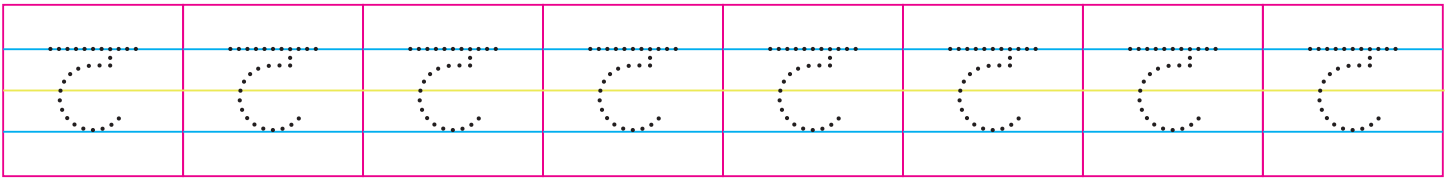

चित्र पहचानकर पहला अक्षर लिखिए व रंग भरिए-

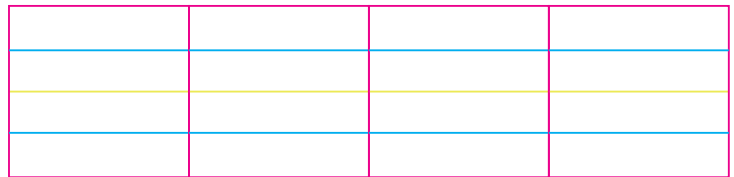
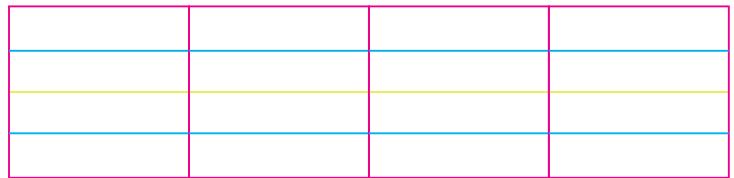
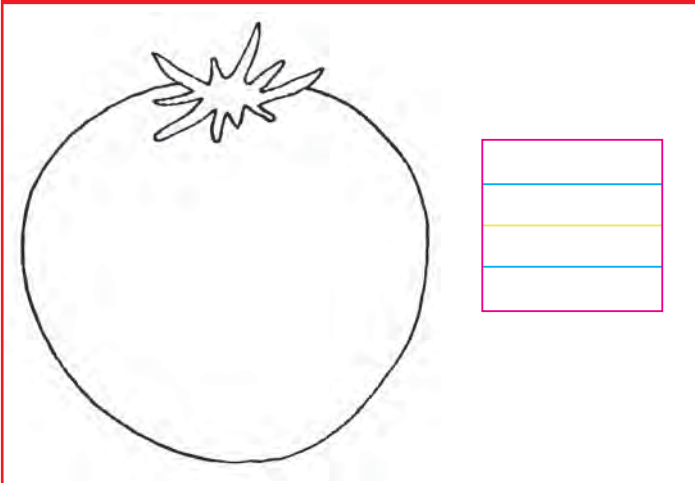

दिनांक:

हस्ताक्षर:

दिनांक

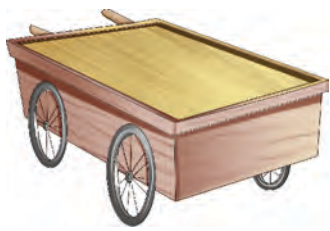

ठेला

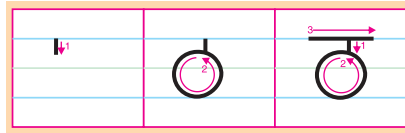
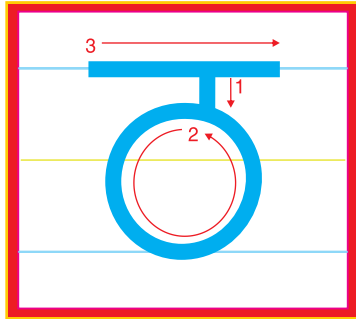

ठठेरा



अभ्यास कीजिए-

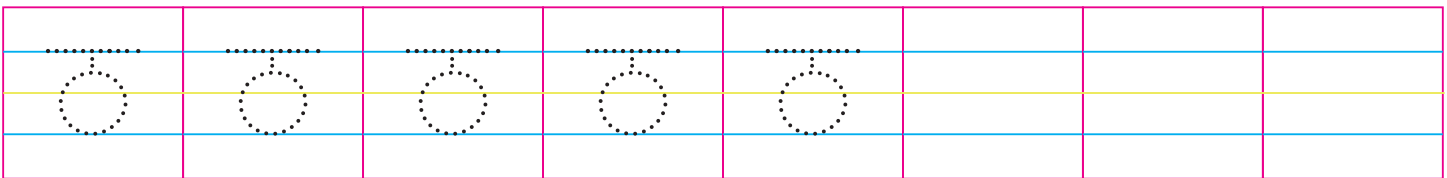
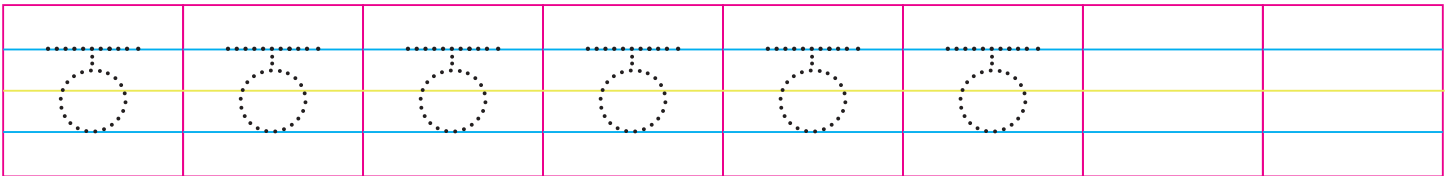
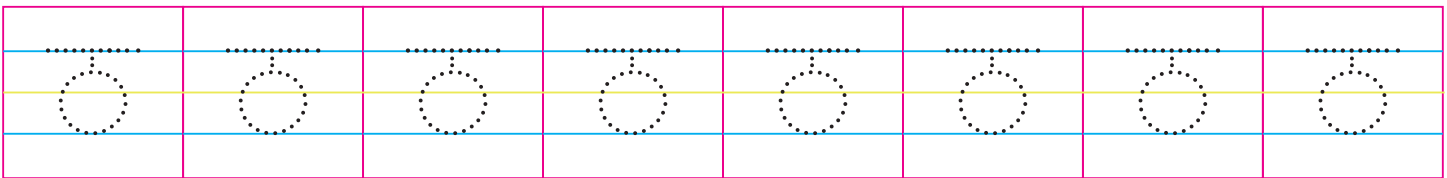

दिए गए चित्र में रंग भरिए-

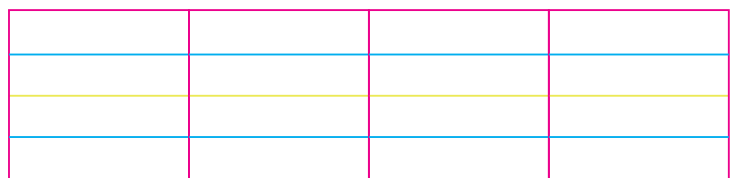
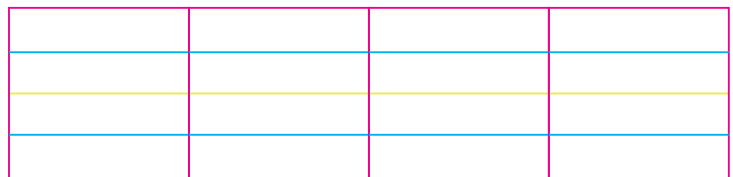
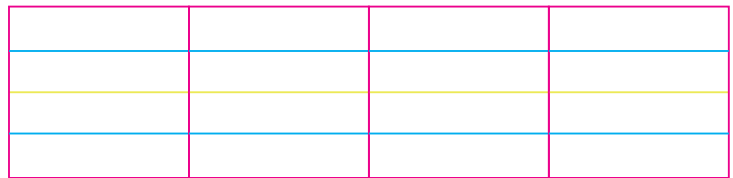

दिनांक:

हस्ताक्षर:

दिनांक



डाकिया

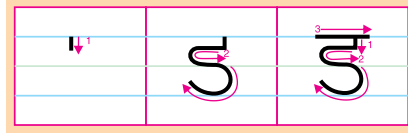
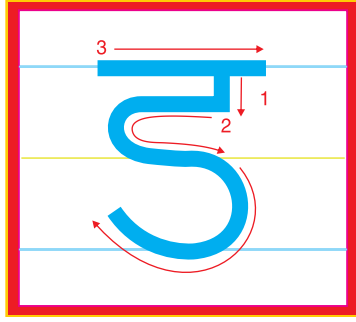

डमरू

अभ्यास कीजिए-

Tracing row 1: Eight boxes containing dotted Hindi letter 'ड' for tracing.

Tracing row 2: Six boxes containing dotted Hindi letter 'ड' for tracing, followed by two empty boxes.

Tracing row 3: Five boxes containing dotted Hindi letter 'ड' for tracing, followed by three empty boxes.

चित्र के प्रथम अक्षर पर सही का निशान लगाइए-



ड

च

ग

Blank writing row 1: Four empty boxes for writing.

Blank writing row 2: Four empty boxes for writing.

Blank writing row 3: Four empty boxes for writing.

दिनांक:

हस्ताक्षर:

दिनांक



ढाल

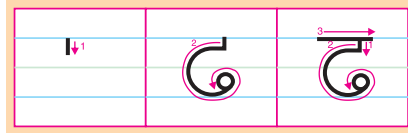
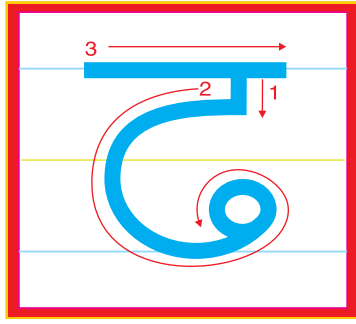

होल

अभ्यास कीजिए-

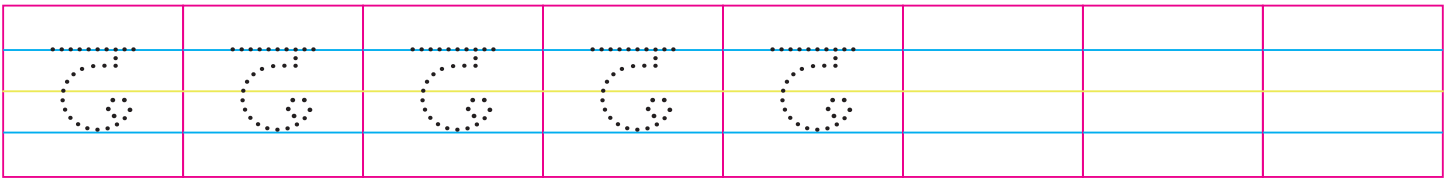
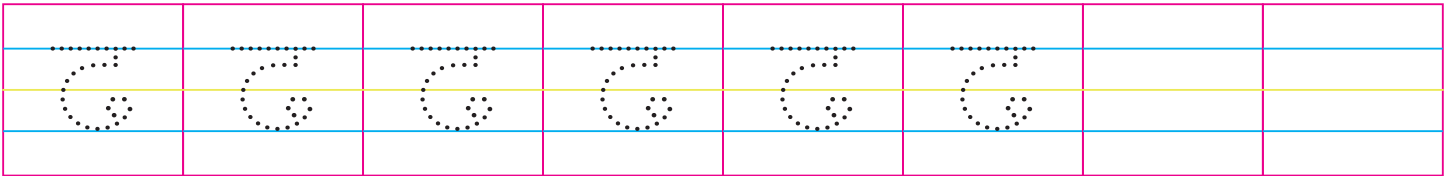
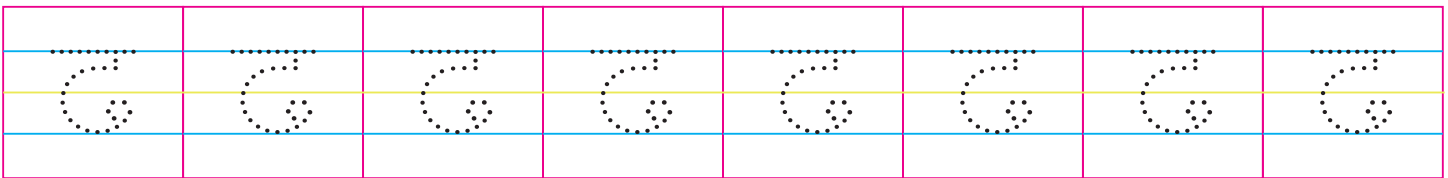

दिए गए चित्र में रंग भरिए-

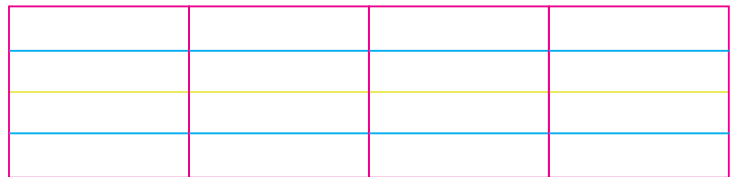
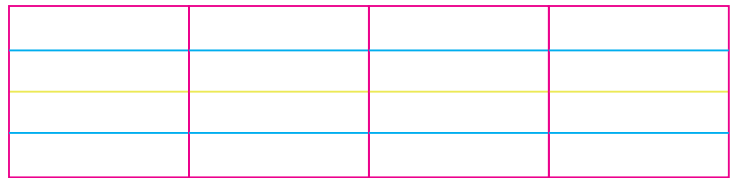
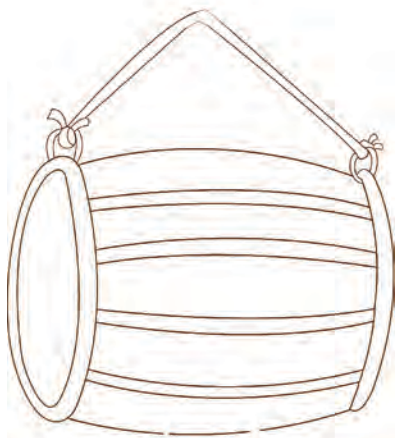

दिनांक:

हस्ताक्षर:

--	--	--	--	--	--



ण

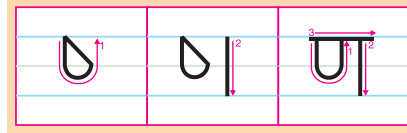
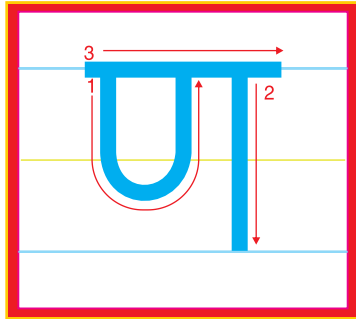

अभ्यास कीजिए-

ण	ण	ण	ण	ण	ण	ण	ण
---	---	---	---	---	---	---	---

ण	ण	ण	ण	ण	ण		
---	---	---	---	---	---	--	--

ण	ण	ण	ण	ण			
---	---	---	---	---	--	--	--

चित्र पहचानकर उनके नाम का पहला अक्षर लिखिए-

	<table border="1"><tr><td></td></tr><tr><td></td></tr><tr><td></td></tr></table>					<table border="1"><tr><td></td></tr><tr><td></td></tr><tr><td></td></tr></table>			
	<table border="1"><tr><td></td></tr><tr><td></td></tr><tr><td></td></tr></table>					<table border="1"><tr><td></td></tr><tr><td></td></tr><tr><td></td></tr></table>			
	<table border="1"><tr><td></td></tr><tr><td></td></tr><tr><td></td></tr></table>								

--	--	--	--

--	--	--	--

--	--	--	--

दिनांक

चित्र पहचानकर सही वर्ण पर गोला (○) लगाइए-



अ

इ

ट



ऊ

ढ

ज



ख

ठ

ञ



प

म

ड



ख

क

ग



क

ग

ख



झ

घ

आ



औ

छ

क



च

ग

ठ

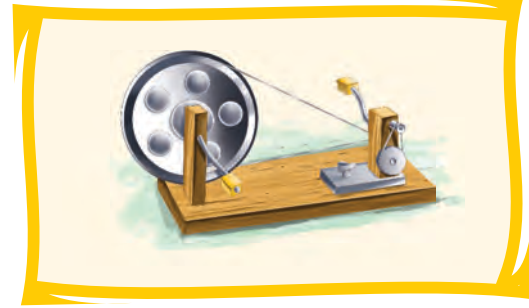

ट

च

क

दिनांक:

हस्ताक्षर:

दिनांक



ताला

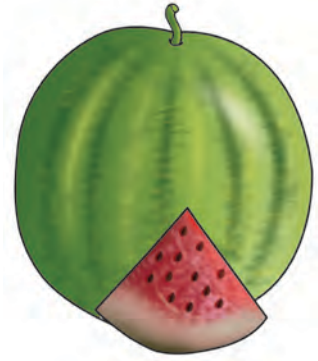
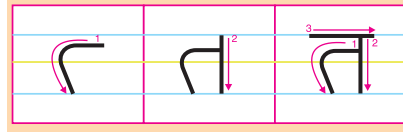
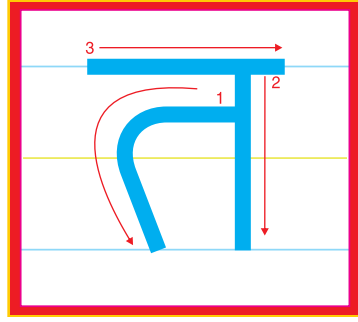

तरबूज़

अभ्यास कीजिए-

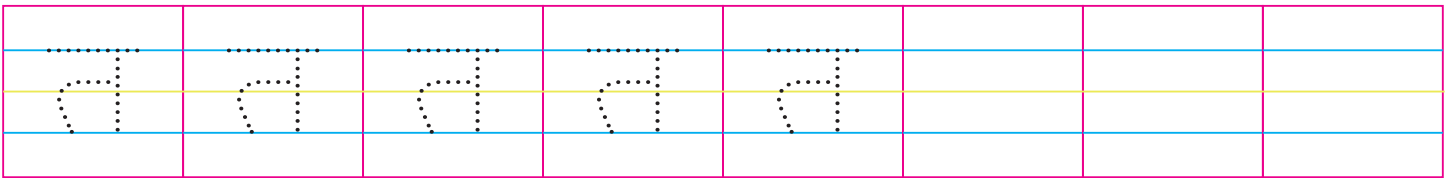
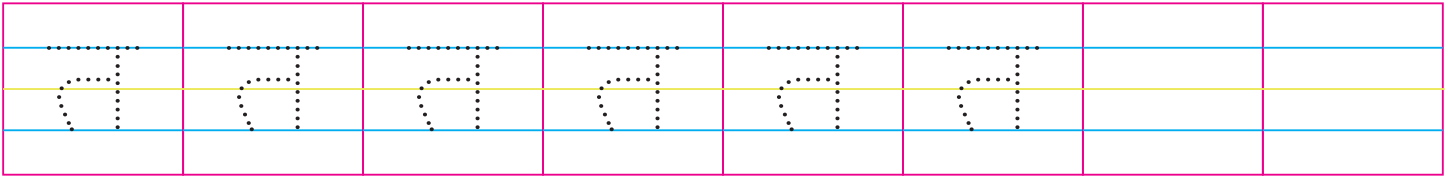
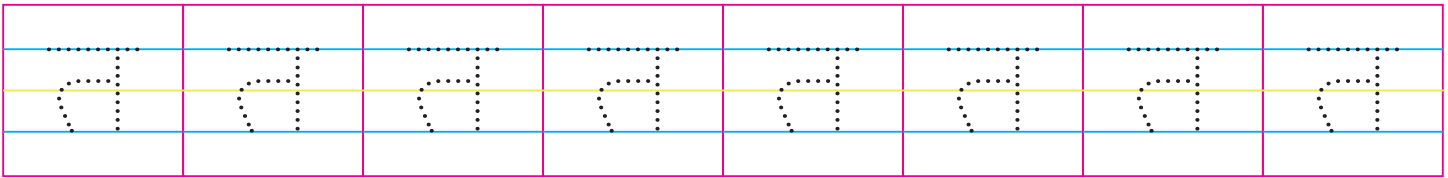

चित्र पहचानकर पहला अक्षर लिखिए
व रंग भरिए-

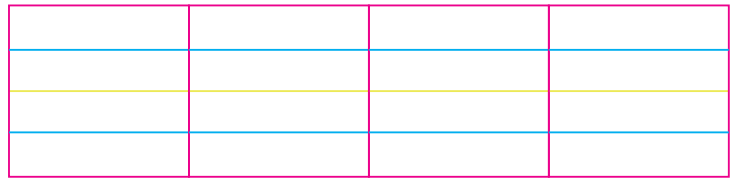
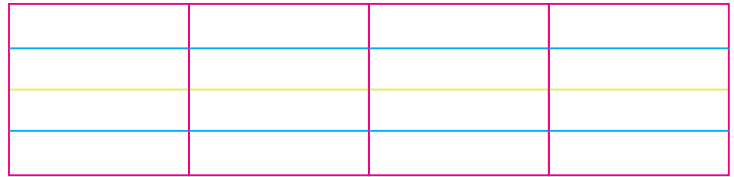
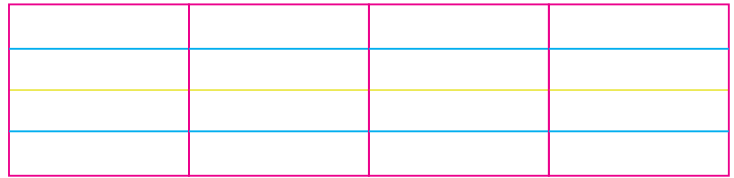
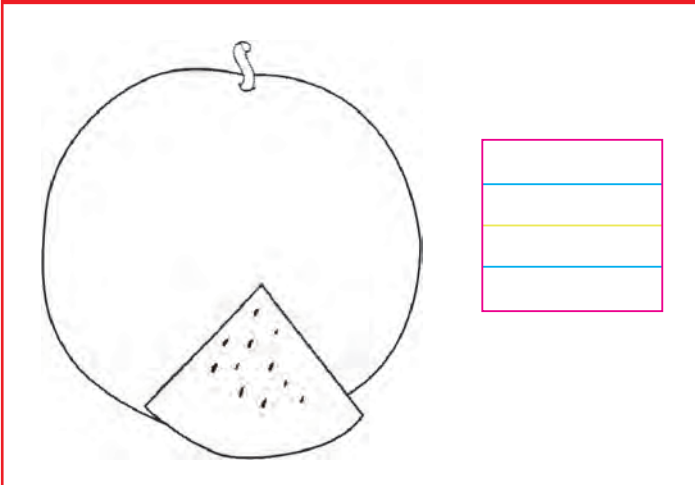

दिनांक:

हस्ताक्षर:

दिनांक



थन

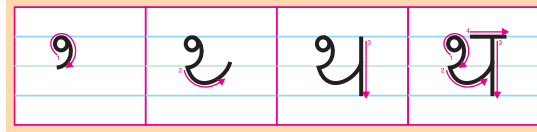
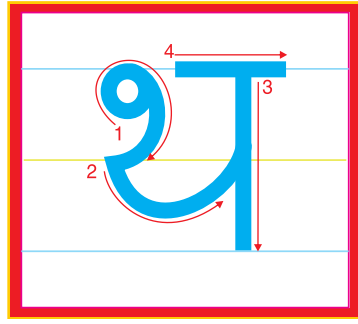

थरमस

अभ्यास कीजिए-

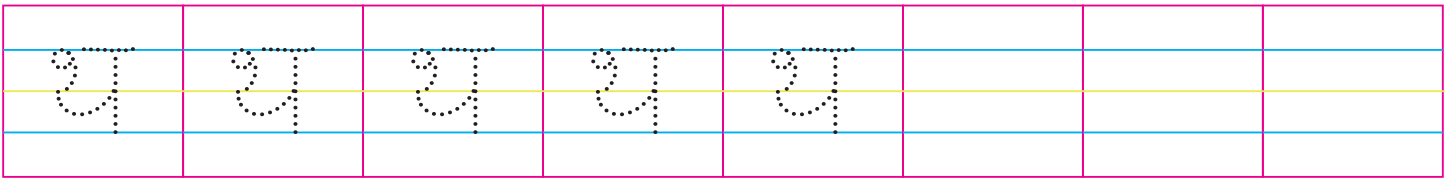
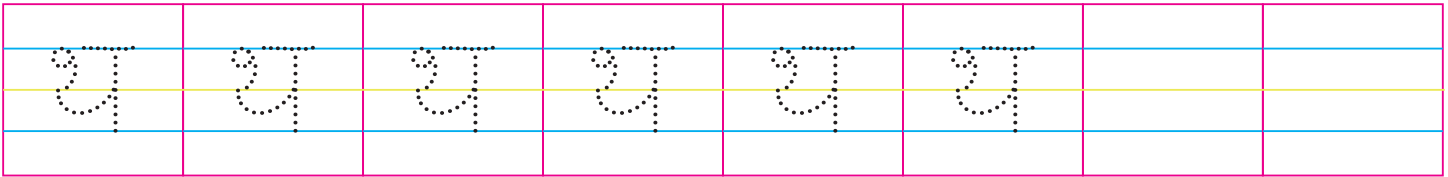
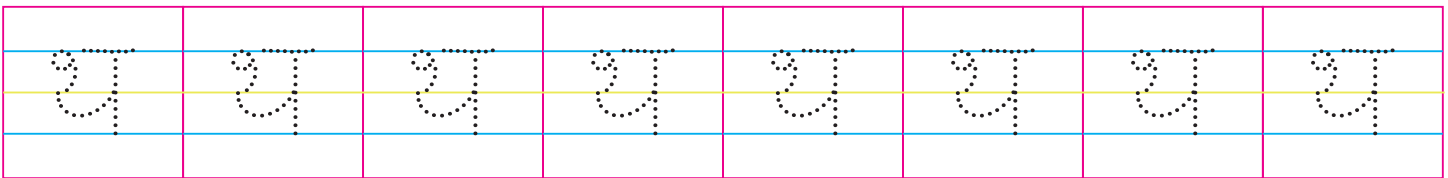

दिए गए चित्र में रंग भरिए-

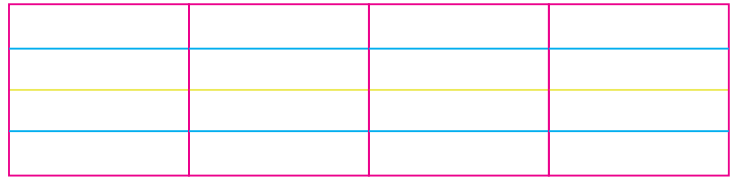
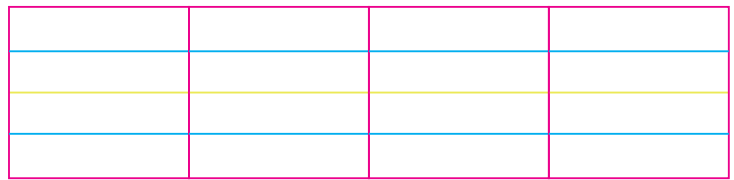

दिनांक:

हस्ताक्षर:

दिनांक



दर्पण

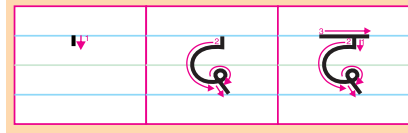
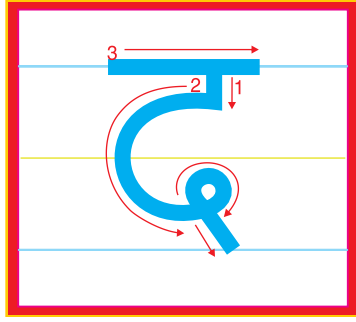

दवात

अभ्यास कीजिए-

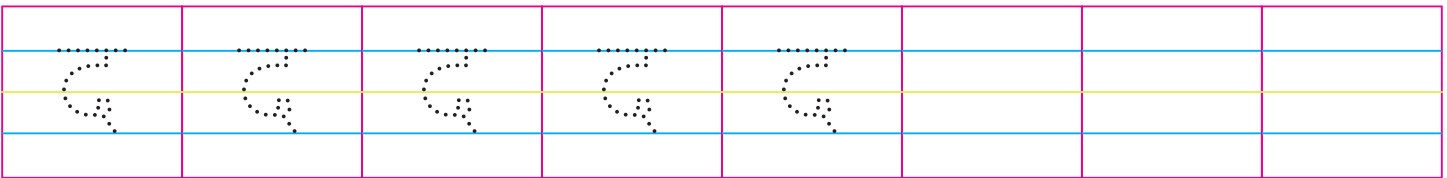
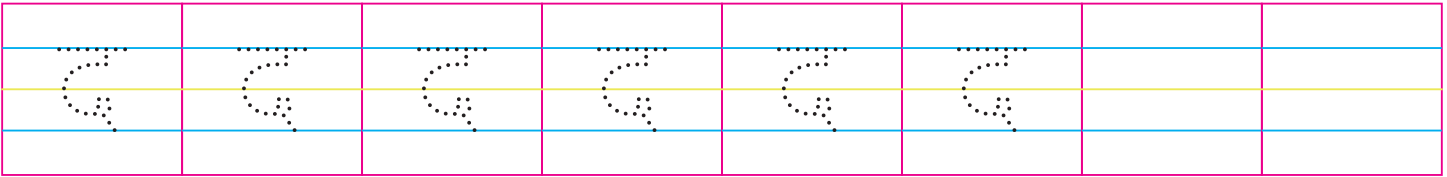
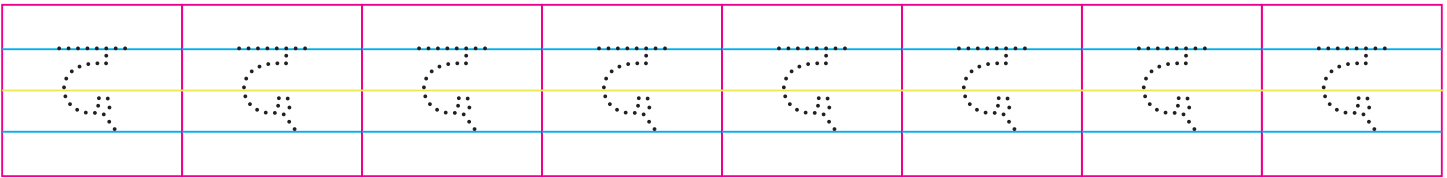

चित्र के प्रथम अक्षर पर सही का निशान लगाइए-



ल

द

त

दिनांक:

हस्ताक्षर:

दिनांक



धन

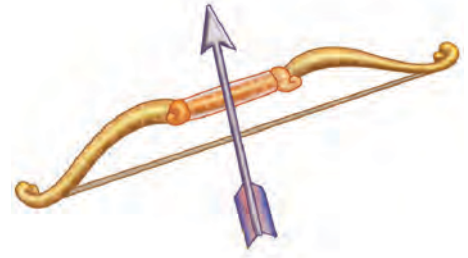
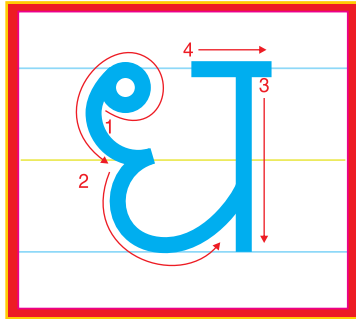

धनुष



अभ्यास कीजिए-

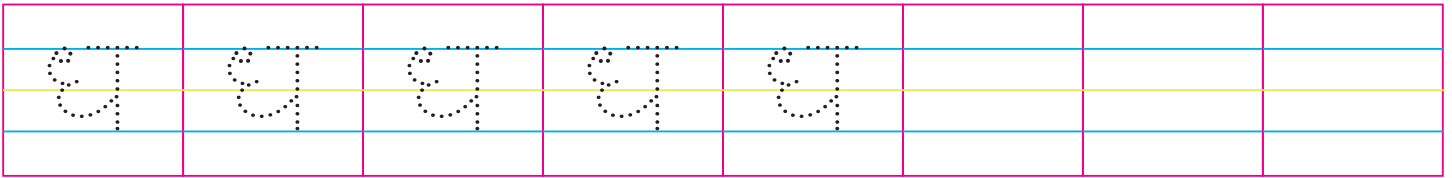
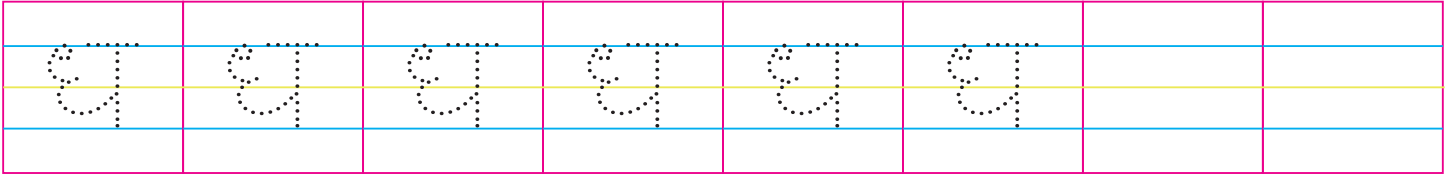
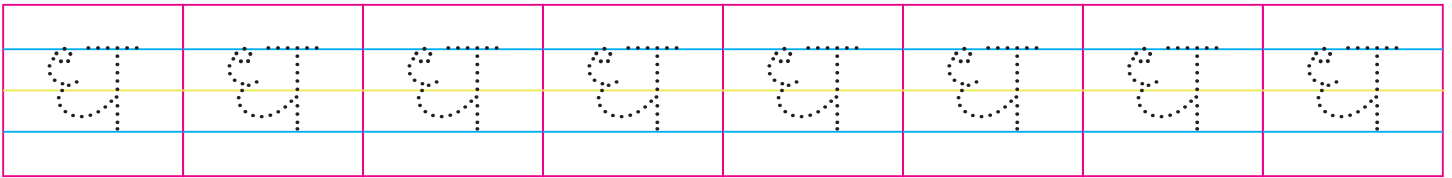

दिए गए चित्र में रंग भरिए-

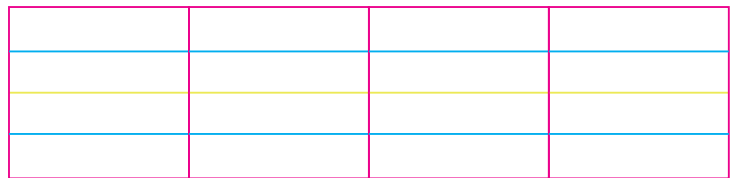
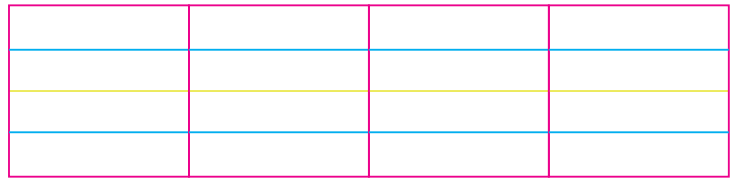
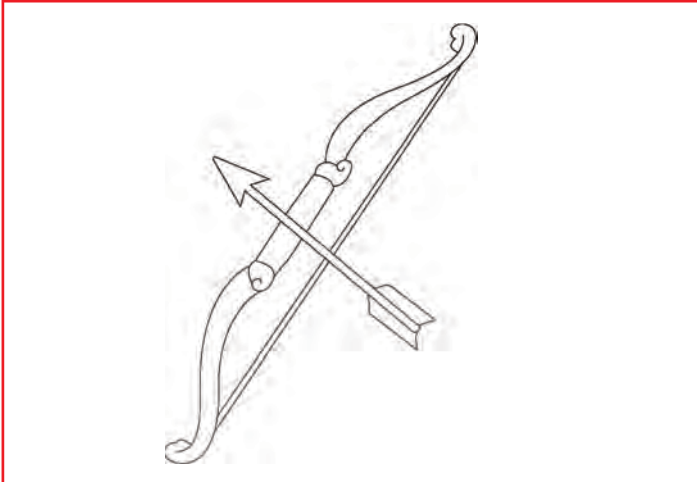

दिनांक:

हस्ताक्षर:

दिनांक



नमक

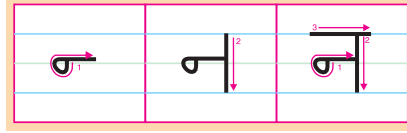
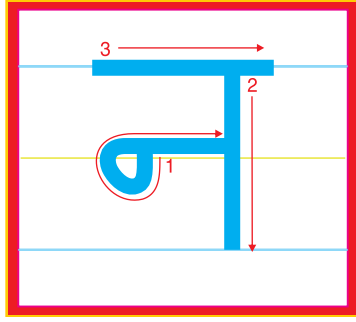

नल

अभ्यास कीजिए-

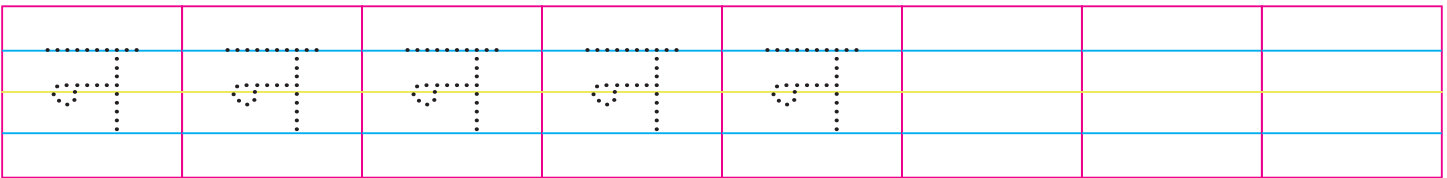
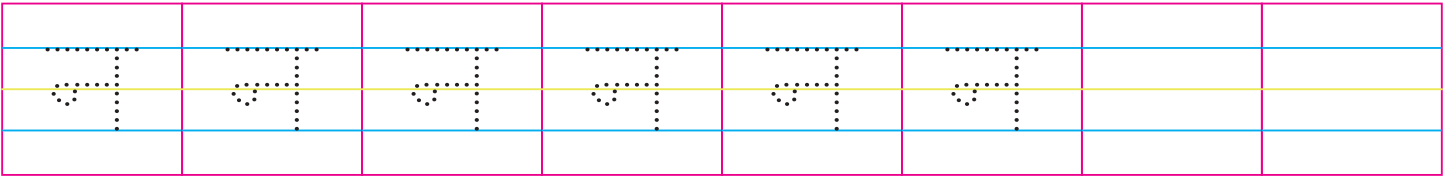
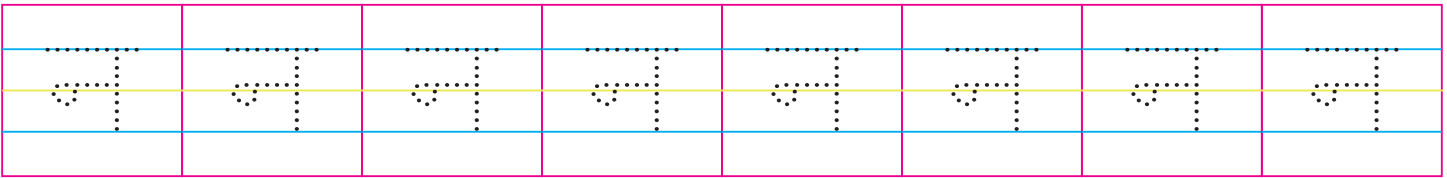

चित्र पहचानकर पहला अक्षर लिखिए
व रंग भरिए-

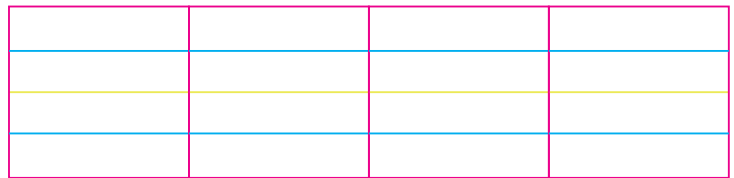
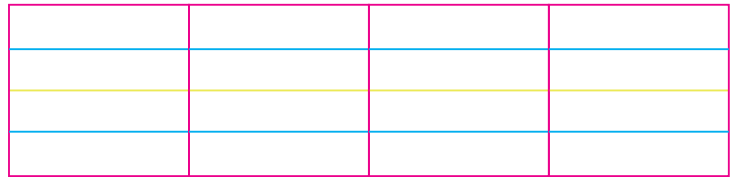
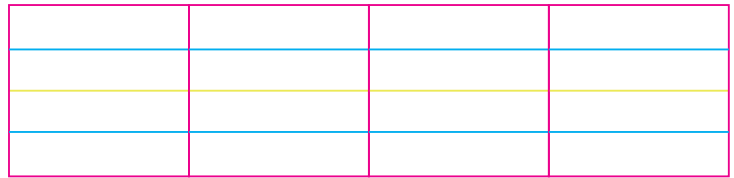
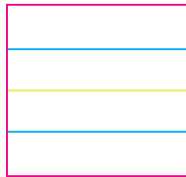
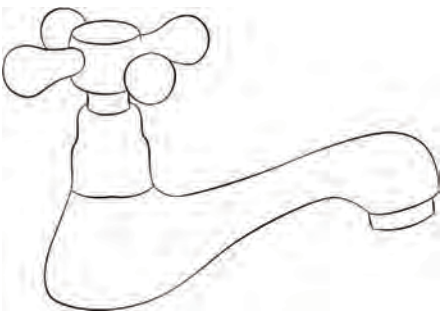

दिनांक:

हस्ताक्षर:

दिनांक

चित्रों के अनुसार सही अक्षर के सामने (✓) लगाइए—

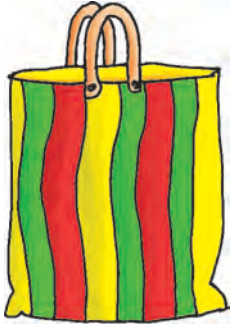

द

थ



द

ध



त

ध



त

ब

चित्रों में रंग भरिए और इनके प्रथम वर्ण लिखिए—

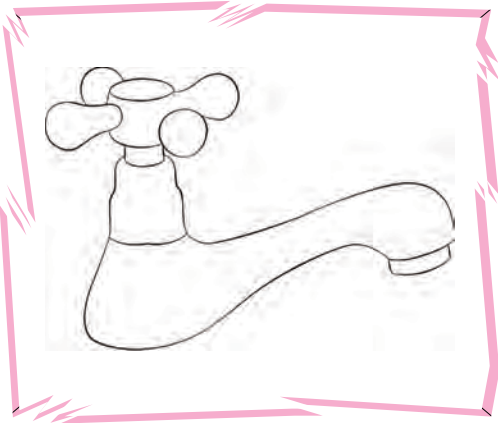

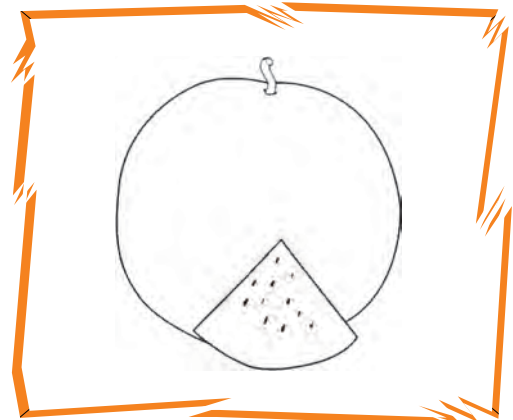

दिनांक:

हस्ताक्षर:

दिनांक



पपीता

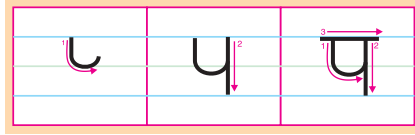
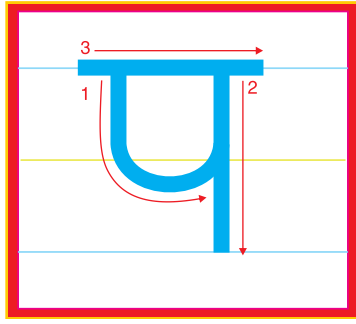

पतंग

अभ्यास कीजिए-

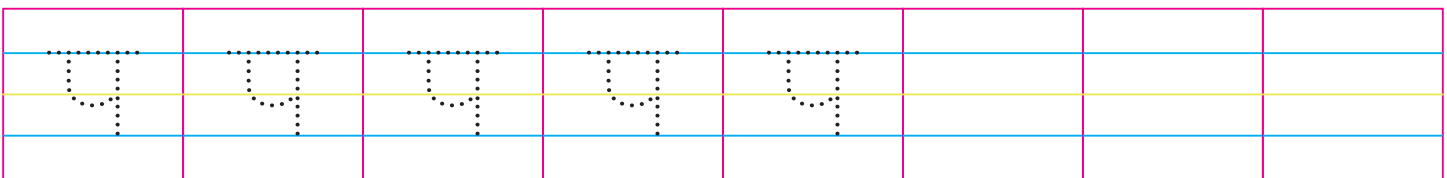
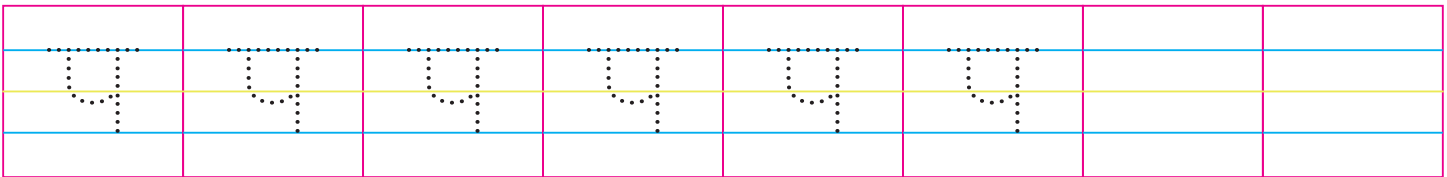
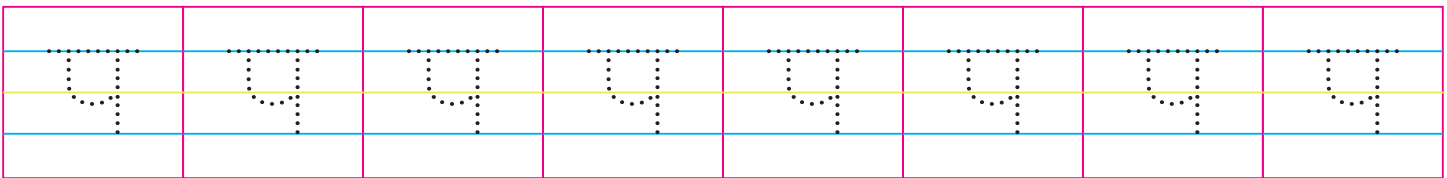

दिए गए चित्र में रंग भरिए-

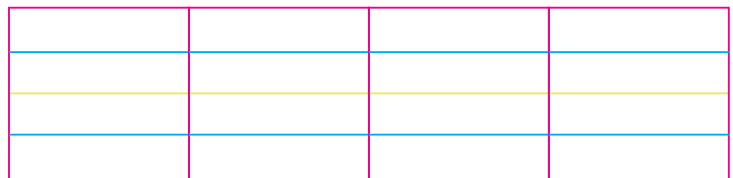

दिनांक:

हस्ताक्षर:

दिनांक



फावड़ा

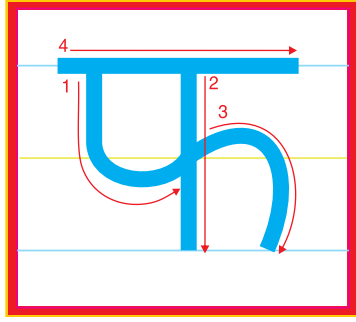

फल

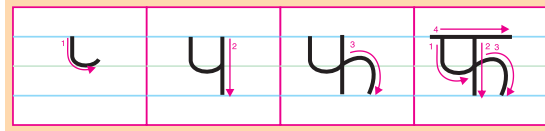

अभ्यास कीजिए-

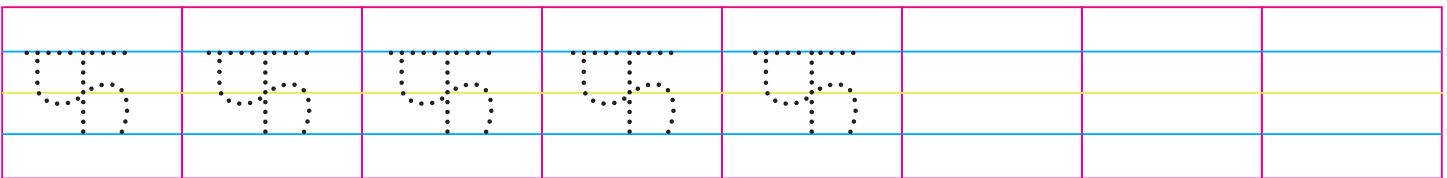
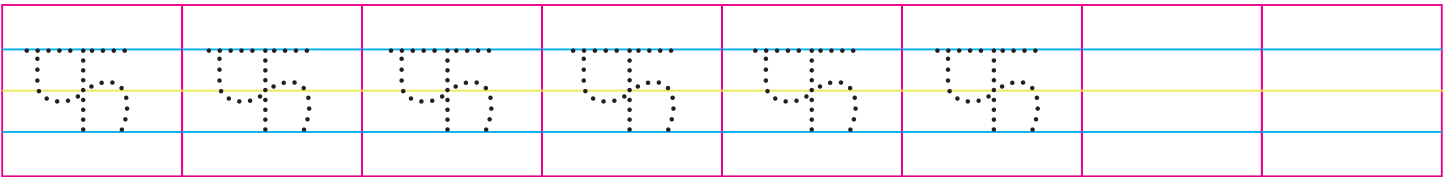
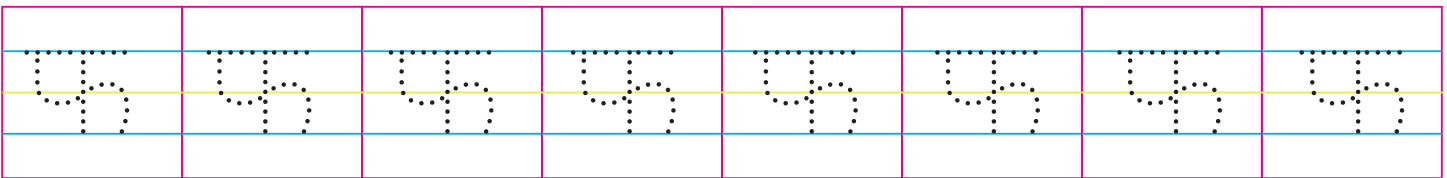

चित्र के प्रथम अक्षर पर सही का निशान लगाइए-



फ

क

न

दिनांक:

हस्ताक्षर:

दिनांक



बकरी

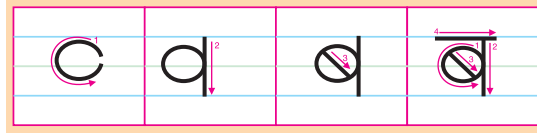
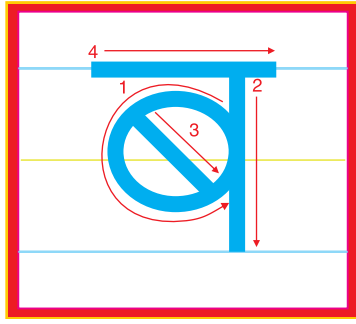

बस

अभ्यास कीजिए-

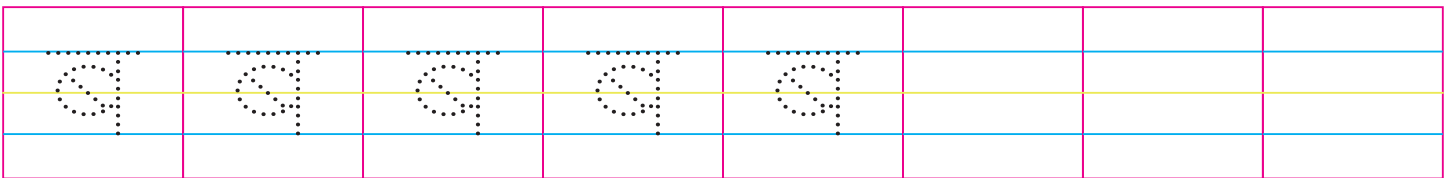
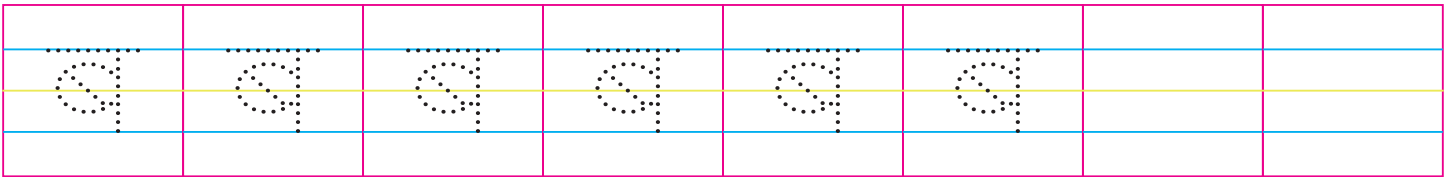
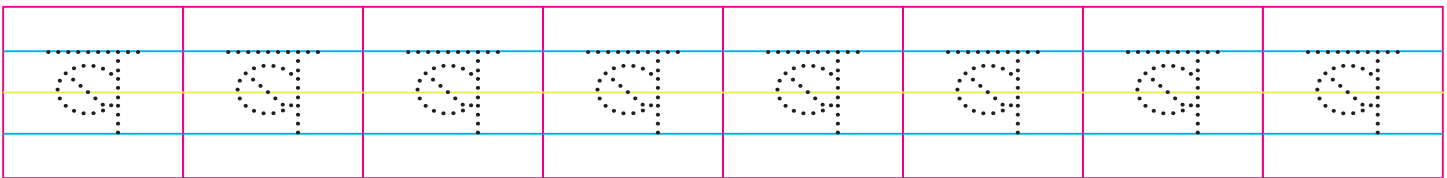

दिए गए चित्र में रंग भरिए-

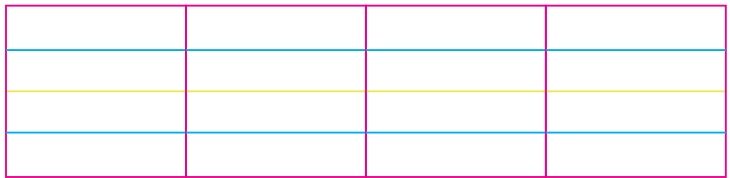
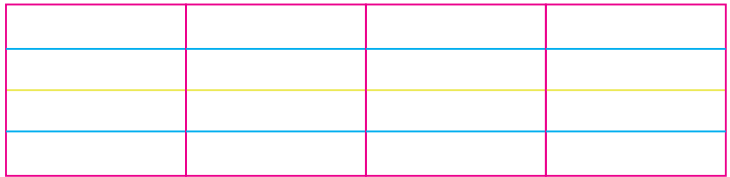
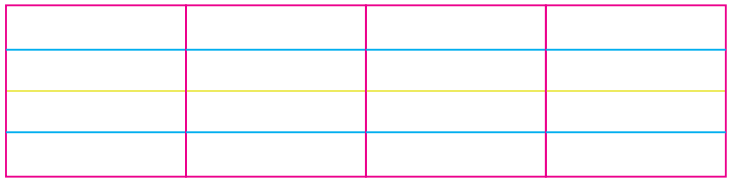
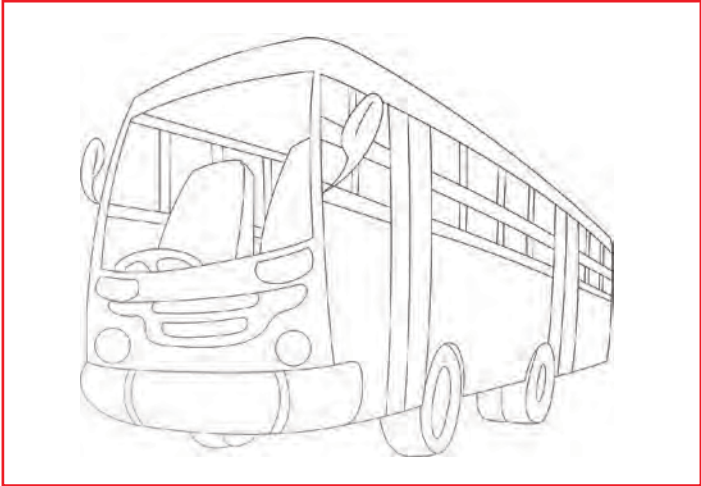

दिनांक:

हस्ताक्षर:

दिनांक



भगत

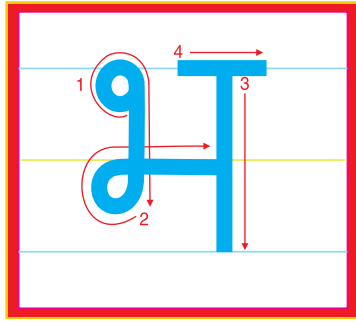

भालू

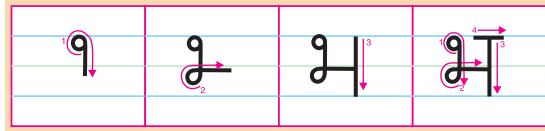

अभ्यास कीजिए-

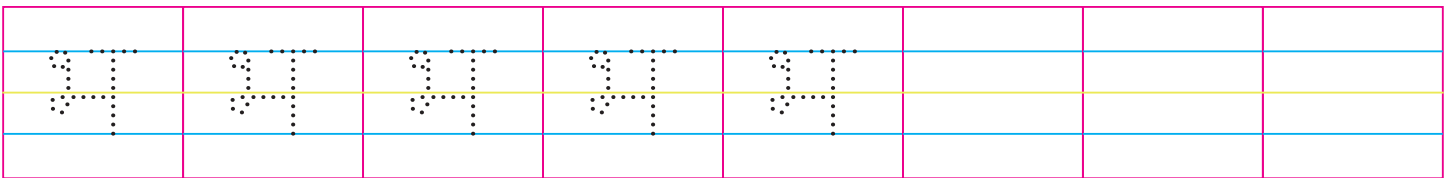
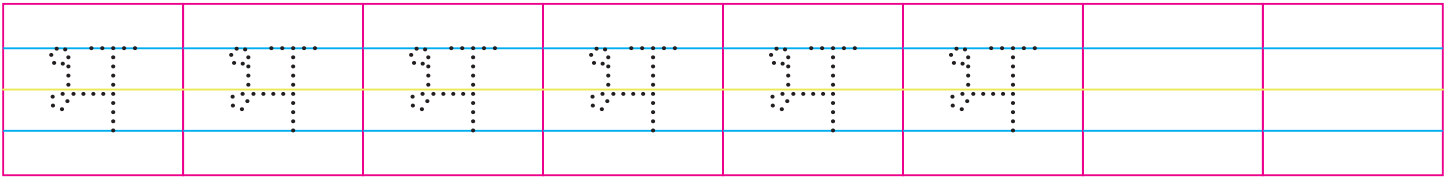
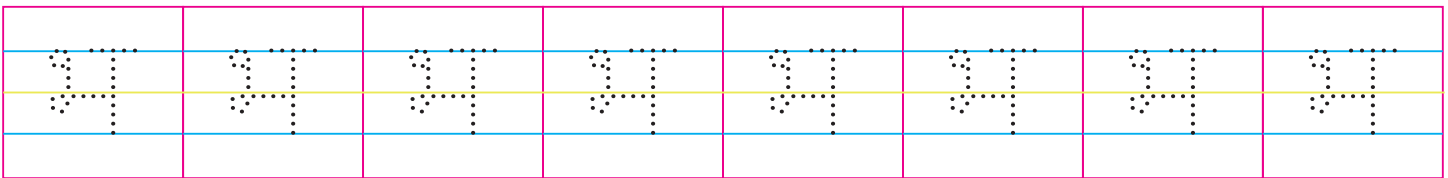

चित्र पहचानकर पहला अक्षर लिखिए व रंग भरिए-

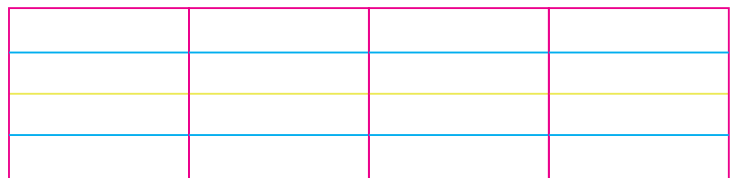
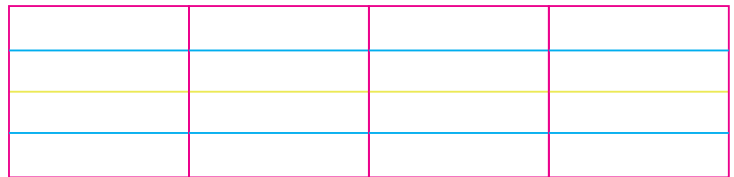
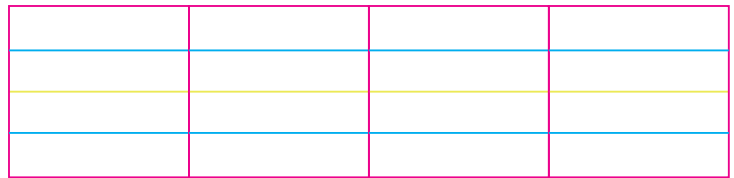
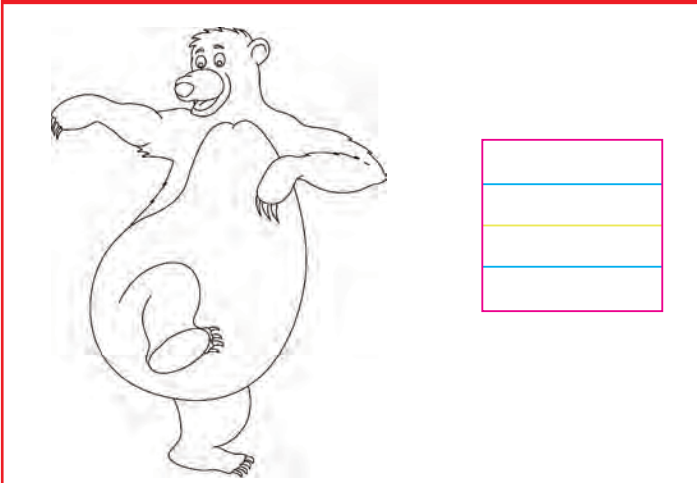

दिनांक:

हस्ताक्षर:

दिनांक



मटर

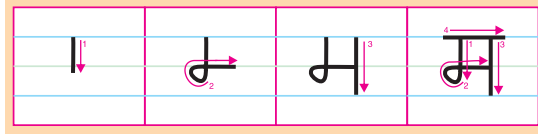
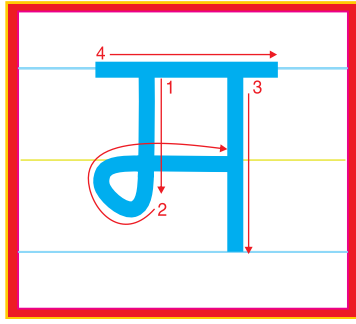

मछली

अभ्यास कीजिए-

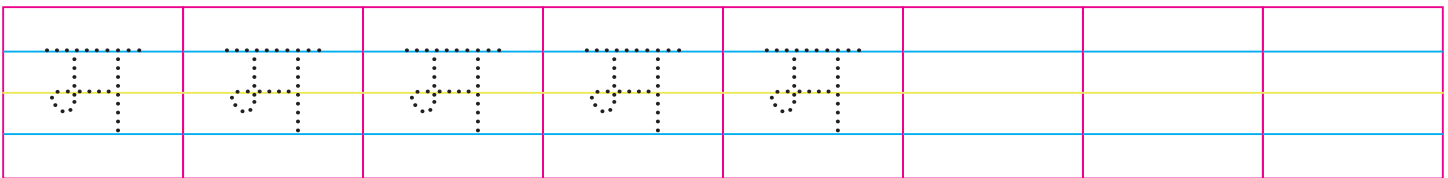
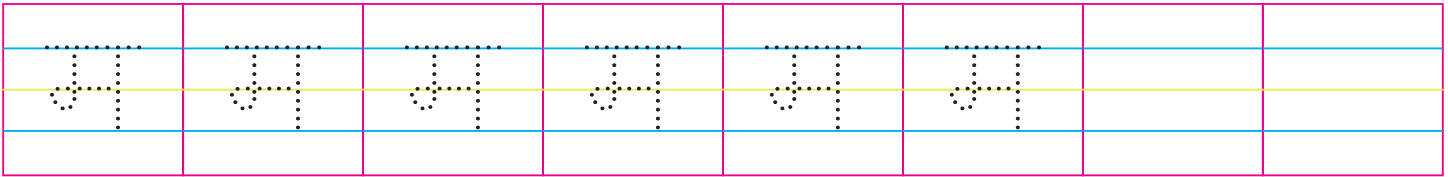
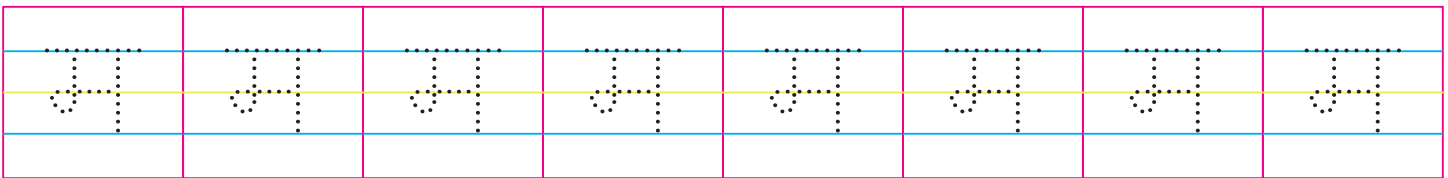

दिए गए चित्र में रंग भरिए-

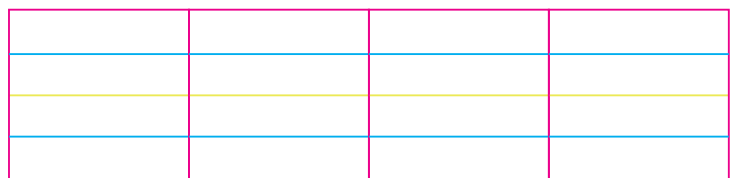
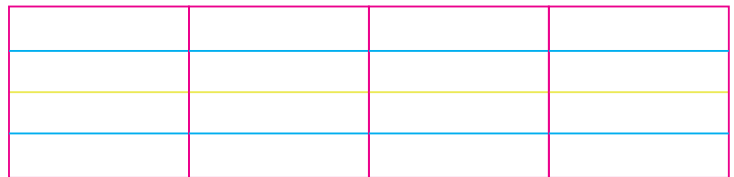
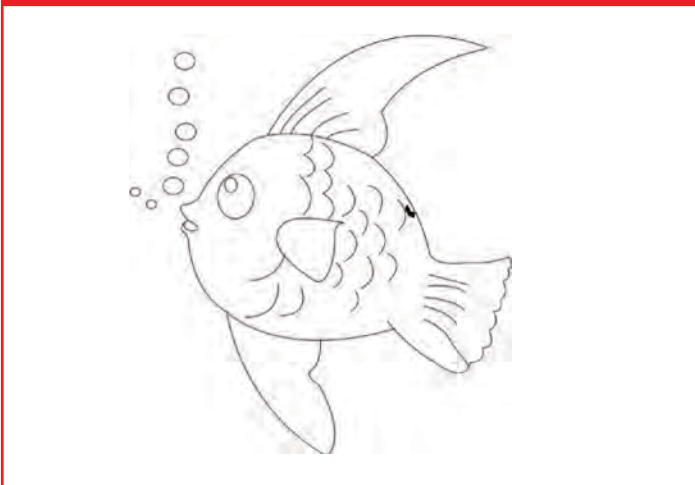

दिनांक:

हस्ताक्षर:

दिनांक

चित्रों का सही अक्षर से मिलान कीजिए—

प
फ
ब
भ
म



चित्र पहचानकर पहला अक्षर लिखो—



दिनांक:

हस्ताक्षर:

दिनांक



यान

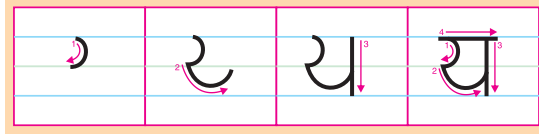
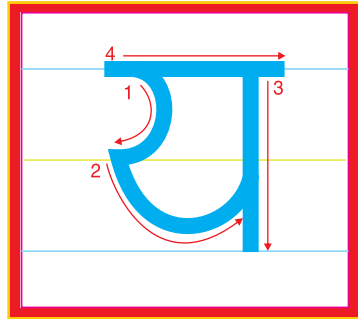

यज्ञ

अभ्यास कीजिए-

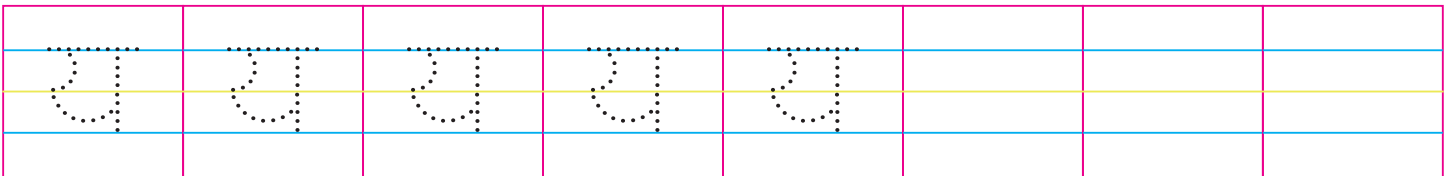
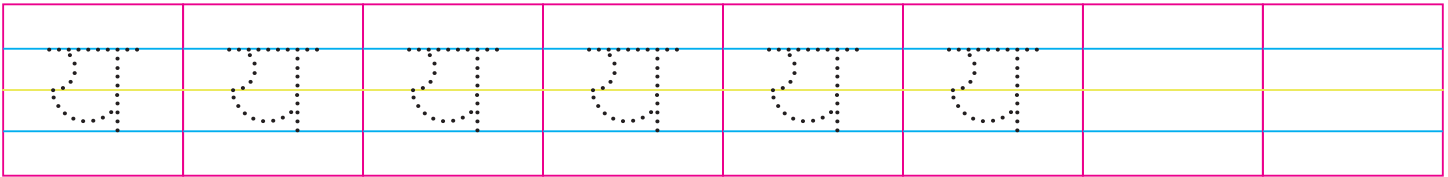
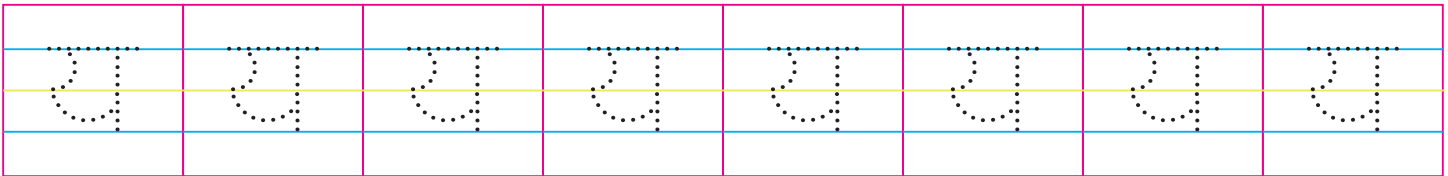

चित्र पहचानकर पहला अक्षर लिखिए व रंग भरिए-

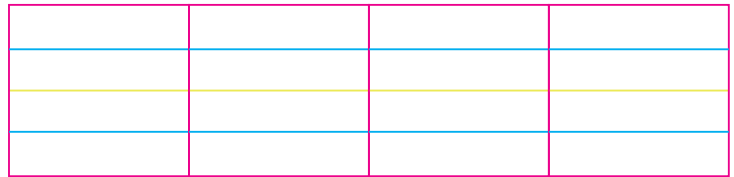
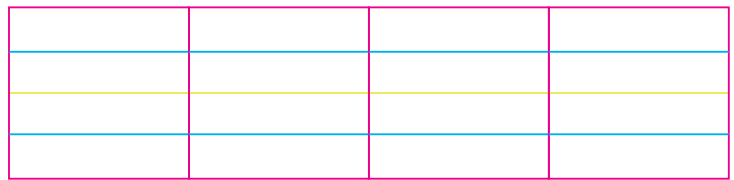
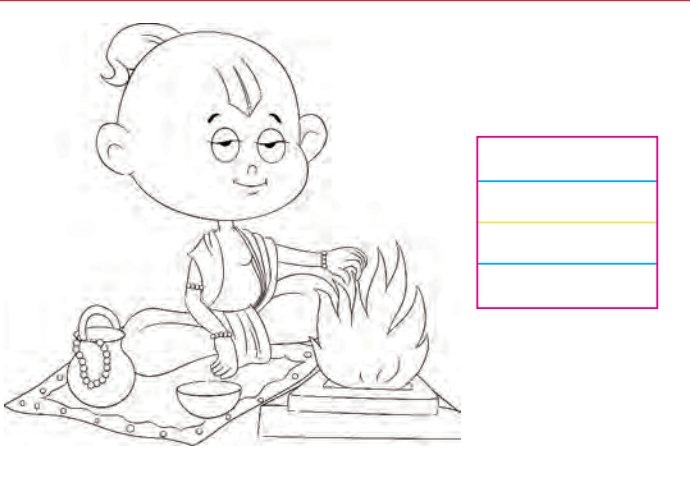

दिनांक:

हस्ताक्षर:

दिनांक



रस्सी

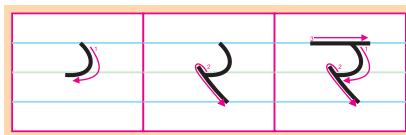
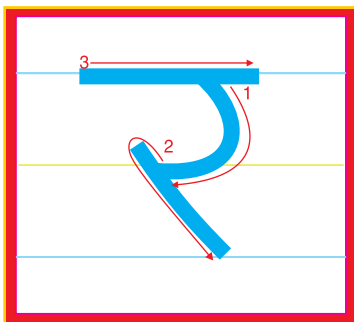

रथ

अभ्यास कीजिए-

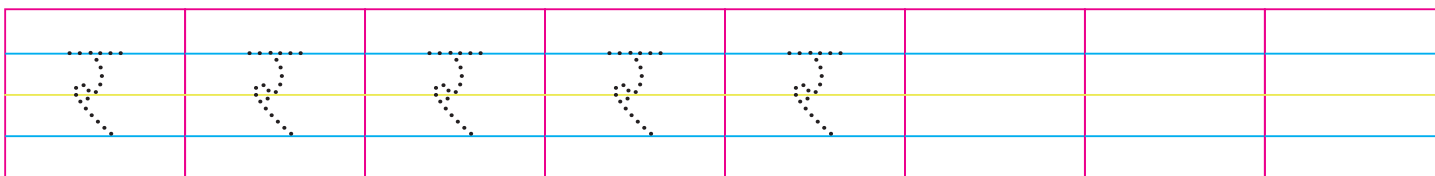
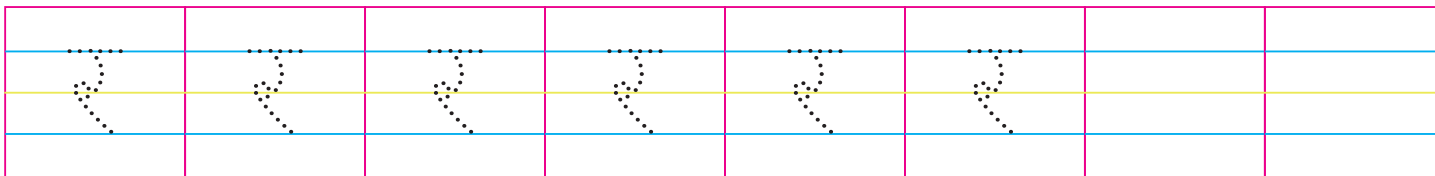
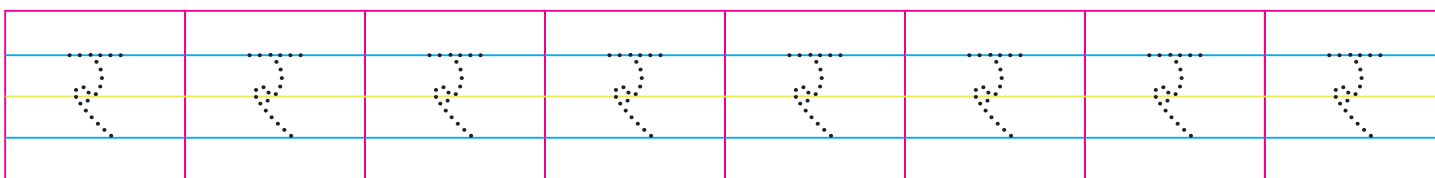

दिए गए चित्र में रंग भरिए-

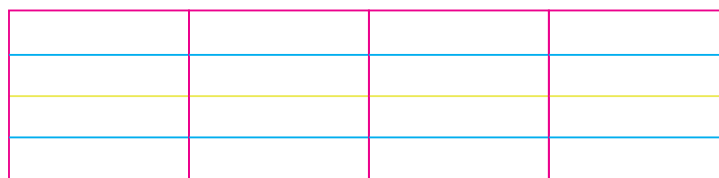

दिनांक:

हस्ताक्षर:

दिनांक



लट्टू

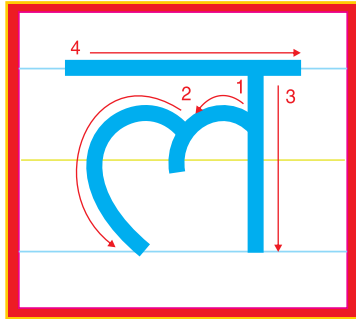

लड़का

अभ्यास कीजिए-

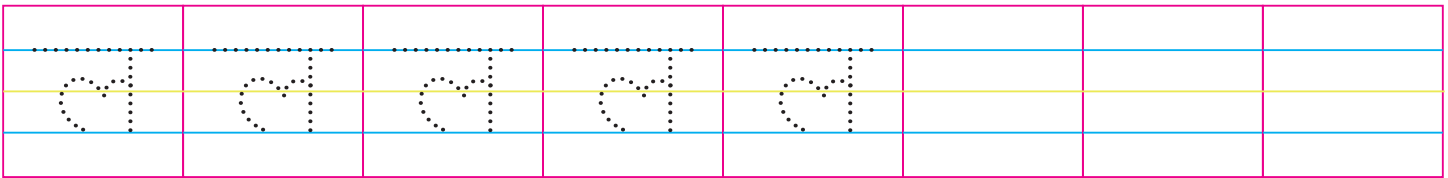
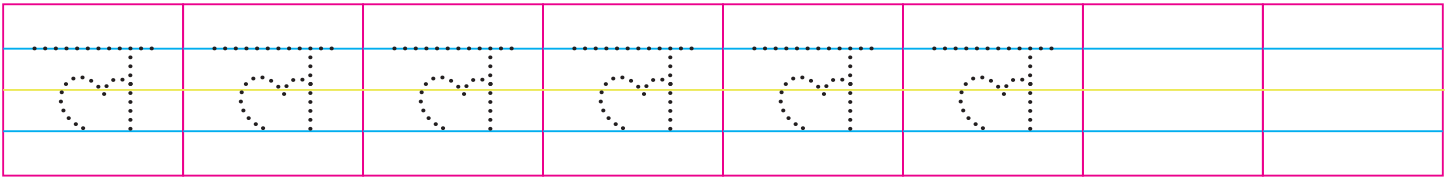
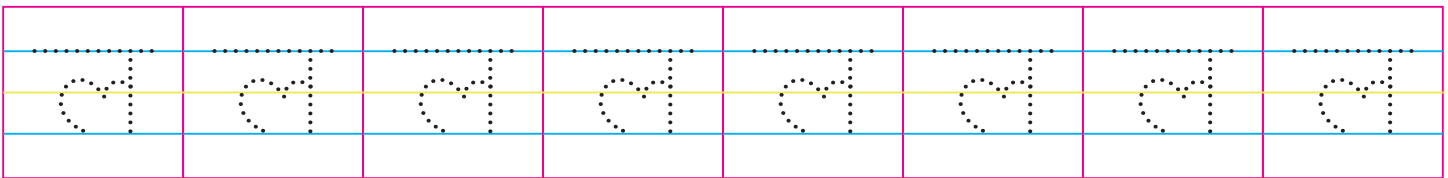

चित्र के प्रथम अक्षर पर सही का निशान लगाइए-



ल

ब

र

दिनांक:

हस्ताक्षर:

दिनांक



वकील

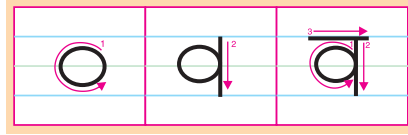
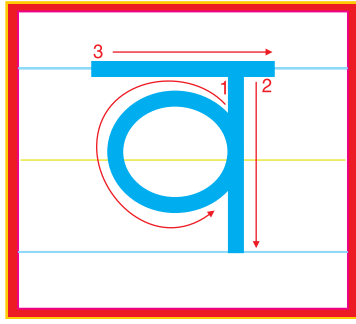

वक

अभ्यास कीजिए-

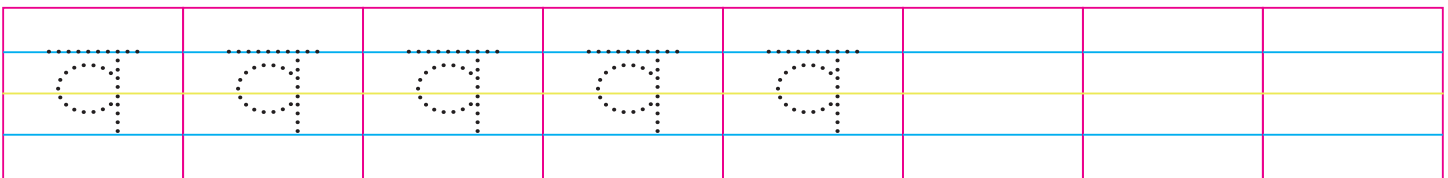
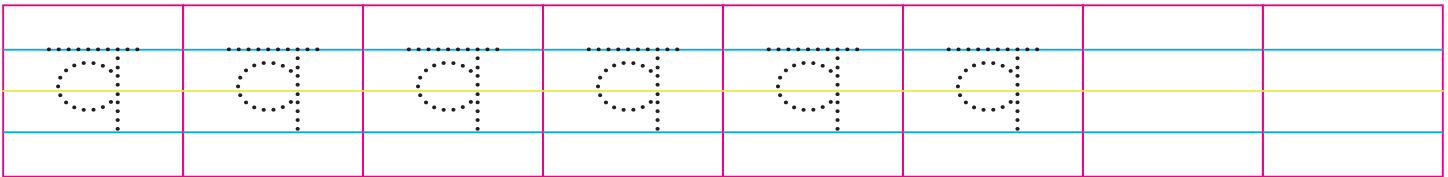
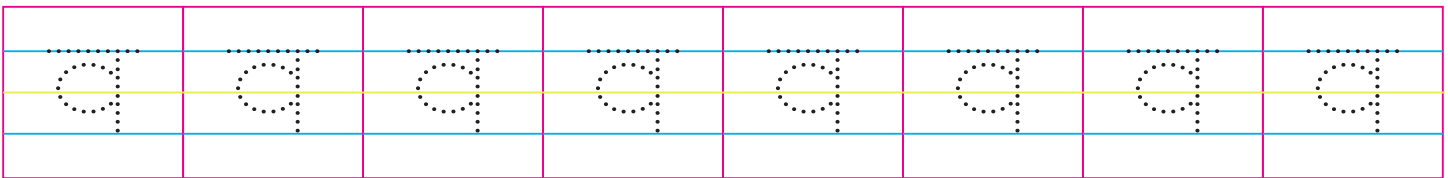

दिए गए चित्र में रंग भरिए-

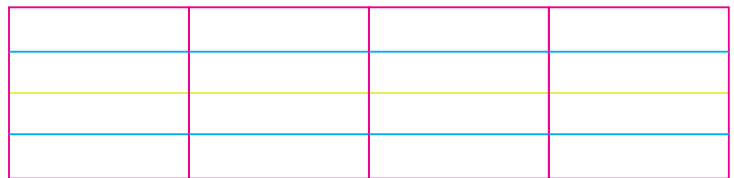
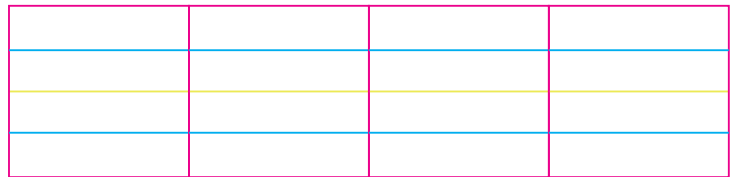
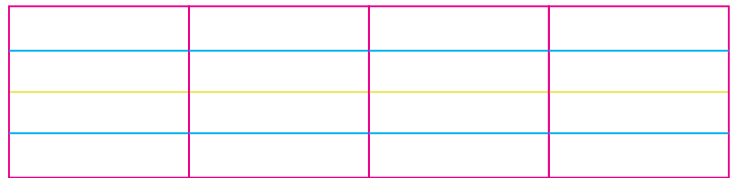

दिनांक:

हस्ताक्षर:

दिनांक



शहद

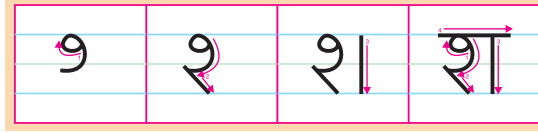
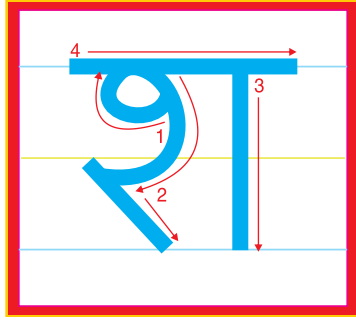

शलगम

अभ्यास कीजिए-

श							
श							

6

षट्

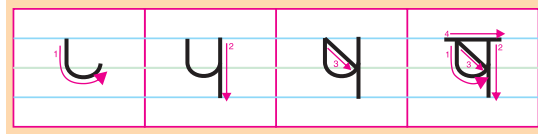
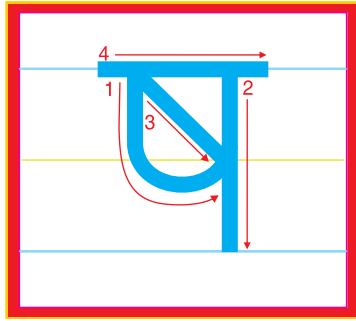

षटकोण

अभ्यास कीजिए-

ष							
ष							

दिनांक:

हस्ताक्षर:

दिनांक



सब्जी

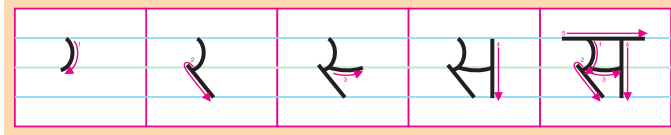
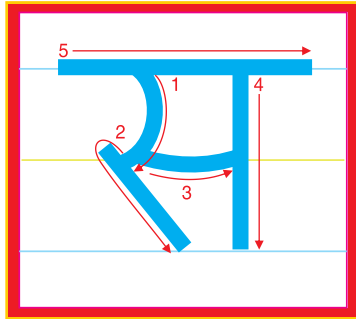

सपेरा

अभ्यास कीजिए-

स							
स							



हल

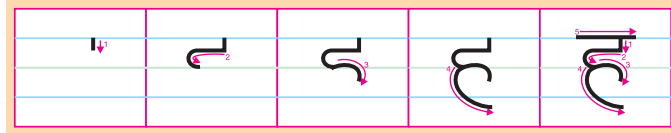
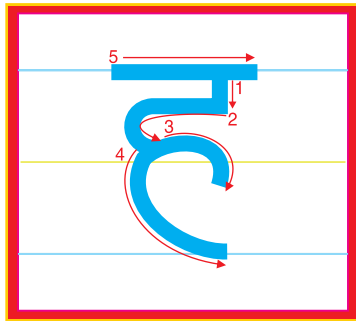

हाथी

अभ्यास कीजिए-

ह							
ह							

दिनांक:

हस्ताक्षर:

दिनांक



क्षमा

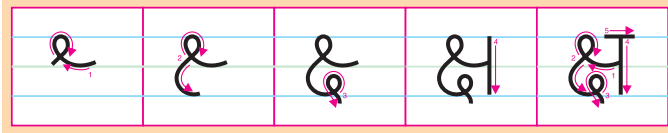
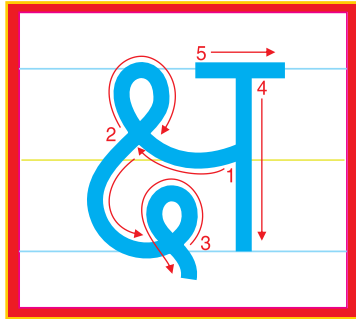

क्षत्रिय

अभ्यास कीजिए-

क्ष							
क्ष							



त्रिभुज

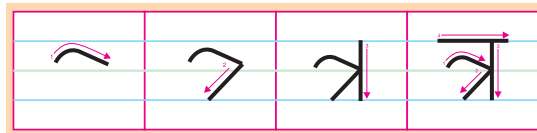
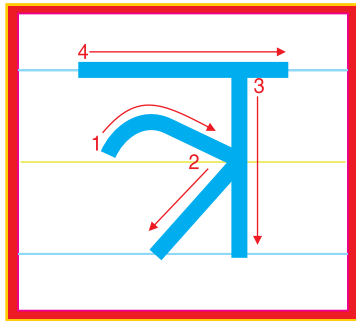

त्रिशूल

अभ्यास कीजिए-

त्र							
त्र							

दिनांक:

हस्ताक्षर:

दिनांक

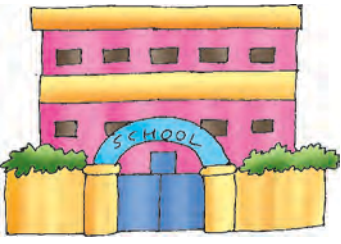

ज्ञानालय

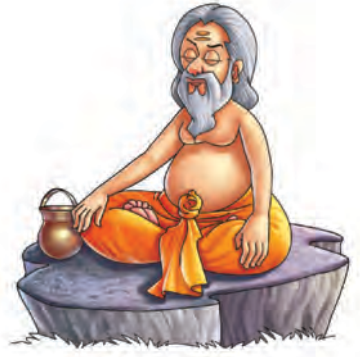
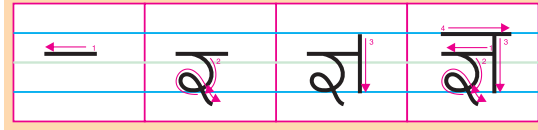
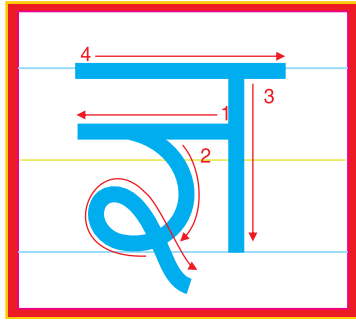

ज्ञानी

अभ्यास कीजिए-

ज्ञ							
ज्ञ							



श्रवण

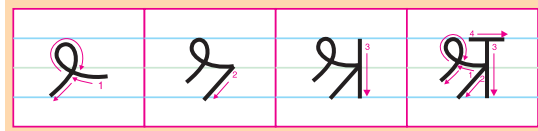
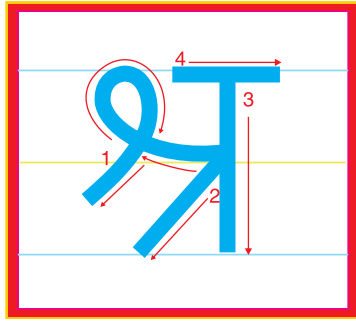

श्रमिक

अभ्यास कीजिए-

श्र							
श्र							

दिनांक:

हस्ताक्षर:

दिनांक



लड़की

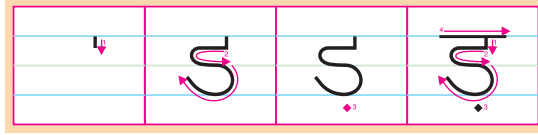
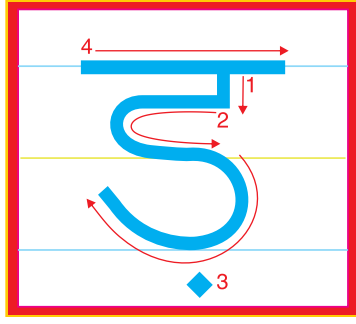

सड़क

अभ्यास कीजिए-



गढ़

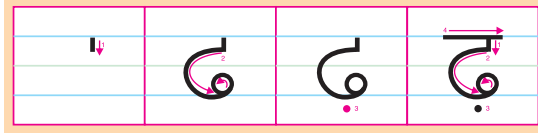
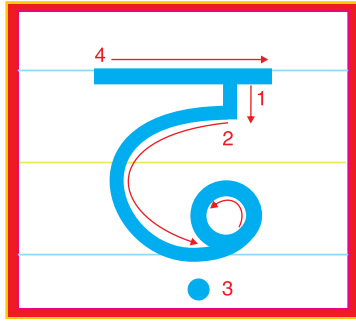

पढ़ना

अभ्यास कीजिए-

दिनांक:

हस्ताक्षर:

दिनांक

स्वर तथा व्यंजन - बोल-बोलकर लिखिए और याद कीजिए-

स्वर

अ	आ	इ	ई	उ	ऊ	ऋ
ए	ऐ	ओ	औ	अं	अः	

व्यंजन

क	ख	ग	घ	ङ
च	छ	ज	झ	ञ
ट	ठ	ड	ढ	ण
त	थ	द	ध	न
प	फ	ब	भ	म
य	र	ल	व	श
ष	स	ह	क्ष	त्र
ज्ञ	श्र		ऌ	

दिनांक:

56

अक्षर रचना

हस्ताक्षर: